



# Service Manual

**GREE ELECTRIC APPLIANCES, INC. OF ZHUHAI**



# Table of Contents

<b>Part I : Technical Information</b> .....	<b>1</b>
<b>1. Summary</b> .....	<b>1</b>
<b>2. Specifications</b> .....	<b>5</b>
2.1 Specification Sheet.....	5
2.2 Capacity Variation Ratio According to Temperature .....	25
2.3 Cooling and Heating Data Sheet in Rated Frequency.....	27
<b>3. Outline Dimension Diagram</b> .....	<b>28</b>
3.1 Indoor Unit.....	28
3.2 Outdoor Unit.....	29
<b>4. Refrigerant System Diagram</b> .....	<b>31</b>
<b>5. Electrical Part</b> .....	<b>32</b>
5.1 Wiring Diagram .....	32
5.2 PCB Printed Diagram .....	35
<b>6. Function and Control</b> .....	<b>40</b>
6.1 Remote Controller Introduction for YAA1FB18(WiFi).....	40
6.2 Remote Controller Introduction for YBE1F/YBE1F1/YBE1FB2.....	45
6.3 GREE+ App Operation Manual .....	50
6.4 Ewpe Smart App Operation Manual.....	51
6.5 Brief Description of Models and Functions.....	52
<b>Part II : Installation and Maintenance</b> .....	<b>54</b>
<b>7. Notes for Installation and Maintenance</b> .....	<b>54</b>
<b>8. Installation</b> .....	<b>60</b>
8.1 Installation Dimension Diagram.....	60
8.2 Installation Parts-checking .....	62
8.3 Selection of Installation Location.....	62

8.4 Electric Connection Requirement .....	62
8.5 Installation of Indoor Unit.....	63
8.6 Installation of Outdoor Unit.....	65
8.7 Vacuum Pumping and Leak Detection.....	66
8.8 Check after Installation and Test Operation .....	67
<b>9. Maintenance .....</b>	<b>68</b>
9.1 Error Code List.....	68
9.2 Procedure of Troubleshooting .....	73
9.3 Troubleshooting for Normal Malfunction .....	88
<b>10. Exploded View and Parts List.....</b>	<b>90</b>
10.1 Indoor Unit.....	90
10.2 Outdoor Unit .....	94
<b>11. Removal Procedure .....</b>	<b>98</b>
11.1 Removal Procedure of Indoor Unit.....	98
11.2 Removal Procedure of Outdoor Unit.....	108
<b>Appendix .....</b>	<b>127</b>
Appendix 1: Reference Sheet of Celsius and Fahrenheit.....	127
Appendix 2: Configuration of Connection Pipe .....	127
Appendix 3: Pipe Expanding Method.....	128
Appendix 4: List of Resistance for Temperature Sensor.....	129

# 1. Summary

## Indoor Unit:

A1 panel(Blue)

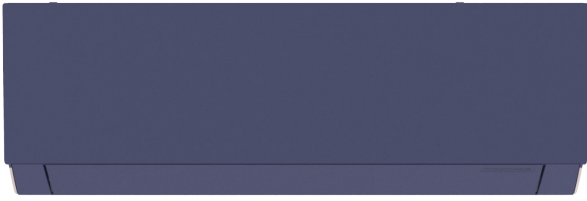

A1 panel(White)



A1 panel(Silver)



A1 panel(Champagne)



A1 panel(Black)

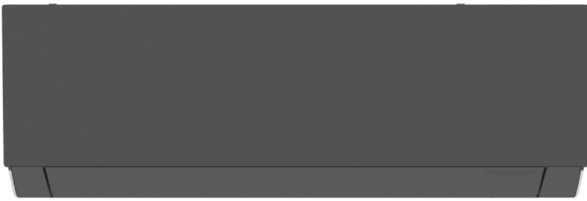

A2 panel(White)



A2 panel(Black)



A2 panel(Silver)



**Outdoor Unit:**

GWH09AUCXB-K6DNA1A/O  
GWH12AUCXB-K6DNA1A/O

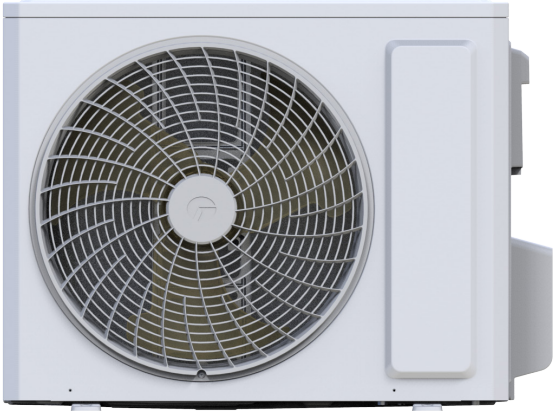

GWH18AUDXD-K6DNA1A/O

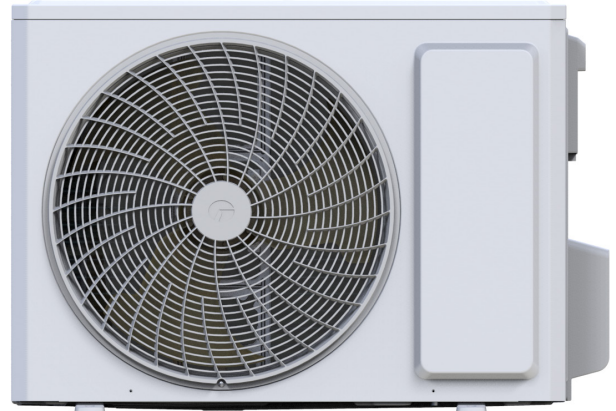

GWH12AUCXD-K6DNA1C/O

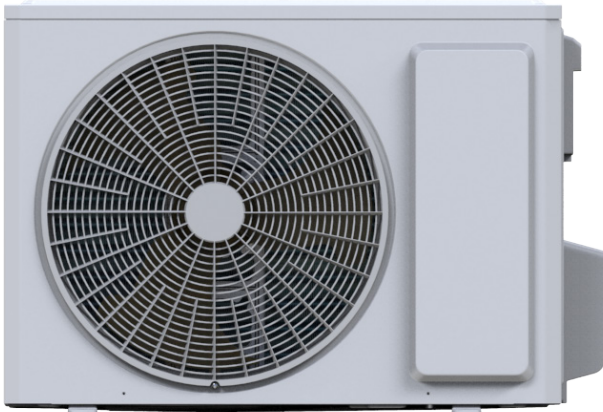

GWH24AUDXF-K6DNA1A/O

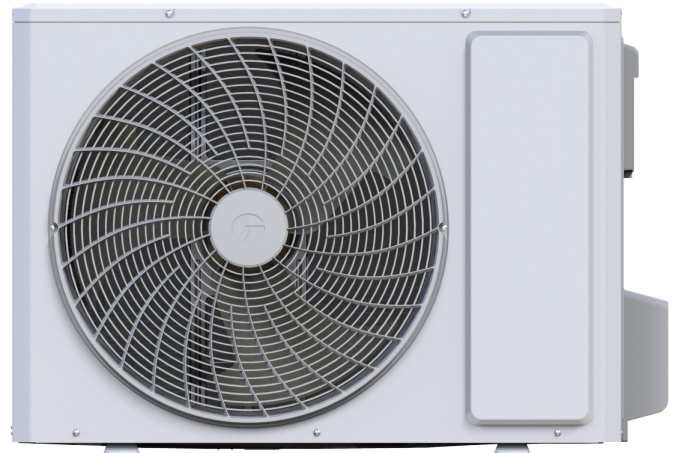

**Remote Controller:**



YAA1FB18(WiFi)

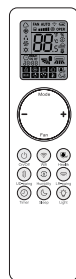

YBE1F/YBE1F1/YBE1FB2

**Model list:**

No.	Model	Product code	Indoor model	Indoor product code	Outdoor model	Outdoor product code	Remote Controller
1	GWH09AUCXB-K6DNA2A	CB597000400	GWH09AUCXB-K6DNA2A/I	CB597N00400	GWH09AUCXB-K6DNA1A/O	CB575W00300	YBE1F
2		CB597000403		CB597N00402			YBE1FB2
3	GWH09AUCXB-K6DNA1A	CB575000300	GWH09AUCXB-K6DNA1A/I	CB575N00300			YBE1F1
4		CB575000302		CB575N00302			YBE1F
5		CB575000303		CB575N00303			YBE1F
6		CB575000304		CB575N00304			YBE1F
7		CB575000307		CB575N00306			YBE1FB2
8		CB575000301		CB575N00300		YBE1F1	
9	CB575000305	CB575N00302	YBE1F				
10	CB575000306	CB575N00306	YBE1FB2				
11	CB575000308	CB575N00308	YAA1FB18 (WiFi)				
12	CB575000309	CB575N00309	YBE1F				
13	CB575000310	CB575N00310	YBE1F1				
14	GWH09AUCXB-K6DNA2A	CB597000401	GWH09AUCXB-K6DNA2A/I	CB597N00400	GWH12AUCXB-K6DNA1A/O	CB575W00200	YBE1F
15		CB597000402		CB597N00402			YBE1FB2
16	GWH12AUCXB-K6DNA2A	CB597000100	GWH12AUCXB-K6DNA2A/I	CB597N00100			YBE1F
17		CB597000102		CB597N00102			YBE1F
18		CB597000103		CB597N00103			YBE1FB2
19	GWH12AUCXB-K6DNA1A	CB575000200	GWH12AUCXB-K6DNA1A/I	CB575N00200			YBE1F1
20		CB575000202		CB575N00202			YBE1F
21		CB575000203		CB575N00203		YBE1F	
22		CB575000204		CB575N00204		YBE1F	
23		CB575000207		CB575N00206		YBE1FB2	
24		CB575000201		CB575N00200		YBE1F1	
25		CB575000205		CB575N00202		YBE1F	
26		CB575000206		CB575N00206		YBE1FB2	
27		CB575000208		CB575N00203		YBE1F	
28		CB575000209		CB575N00204	YBE1F		
29	CB575000210	CB575N00210	YAA1FB18 (WiFi)				
30	GWH12AUCXB-K6DNA2A	CB597000101	GWH12AUCXB-K6DNA2A/I	CB597N00100	YBE1F		
31	GWH12AUCXD-K6DNA1C	CB575000700	GWH12AUCXD-K6DNA1C/I	CB575N00700	CB575W00700	YBE1F1	
32		CB575000705		CB575N00705		YBE1F	
33		CB575000704		CB575N00704		YBE1FB2	
34		CB575000701		CB575N00700	CB575W00701	YBE1F1	
35		CB575000702		CB575N00702		YBE1F	
36		CB575000703		CB575N00703		YBE1F1	
37	GWH12AUCXD-K6DNA2C	CB597000601	GWH12AUCXD-K6DNA2C/I	CB597N00600	YBE1F		

**Model list:**

38		CB597000200		CB597N00200			YBE1F
39	GWH18AUDXD-K6DNA2A	CB597000204	GWH18AUDXD-K6DNA2A/I	CB597N00204			YBE1FB2
40		CB597000203		CB597N00203			YBE1F
41		CB575000100		CB575N00100		CB575W00100	YBE1F1
42		CB575000102		CB575N00102			YBE1F
43		CB575000103		CB575N00103			YBE1F
44		CB575000104		CB575N00104			YBE1F
45		CB575000107		CB575N00105	GWH18AUDXD-K6DNA1A/O		YBE1FB2
46	GWH18AUDXD-K6DNA1A	CB575000101	GWH18AUDXD-K6DNA1A/I	CB575N00100			YBE1F1
47		CB575000105		CB575N00102			YBE1F
48		CB575000106		CB575N00105			YBE1FB2
49		CB575000108		CB575N00104		CB575W00101	YBE1F
50		CB575000109		CB575N00103			YBE1F
51		CB575000110		CB575N00110			YAA1FB18 (WiFi)
52	GWH18AUDXD-K6DNA2A	CB597000202	GWH18AUDXD-K6DNA2A/I	CB597N00200			YBE1F
53	GWH24AUDXF-K6DNA2A	CB597000300	GWH24AUDXF-K6DNA2A/I	CB597N00300			YBE1F
54		CB597000303		CB597N00302			YBE1FB2
55		CB437004700		CB437N04700		CB437W04700	YBE1F1
56		CB437004702		CB437N04702			YBE1F
57		CB437004703		CB437N04703			YBE1F
58		CB437004704		CB437N04704			YBE1F
59		CB437004707		CB437N04706			YBE1FB2
60	GWH24AUDXF-K6DNA1A	CB437004701	GWH24AUDXF-K6DNA1A/I	CB437N04700	GWH24AUDXF-K6DNA1A/O		YBE1F1
61		CB437004705		CB437N04702			YBE1F
62		CB437004706		CB437N04706			YBE1FB2
63		CB437004708		CB437N04704			YBE1F
64		CB437004709		CB437N04703		CB437W04701	YBE1F
65		CB437004710		CB437N04710			YAA1FB18 (WiFi)
66	GWH24AUDXF-K6DNA2A	CB597000301	GWH24AUDXF-K6DNA2A/I	CB597N00300			YBE1F
67		CB597000302		CB597N00302			YBE1FB2

# 2. Specifications

## 2.1 Specification Sheet

Model			1.GWH09AUCXB-K6DNA1A 2.GWH09AUCXB-K6DNA2A	
Product Code			1.CB575000300/CB575000302/CB575000303/CB575000304/CB575000307 2.CB597000400/CB597000403	
Power Supply	Rated Voltage	V~	220-240	
	Rated Frequency	Hz	50	
	Phases		1	
Power Supply Mode			Outdoor	
Cooling Capacity		W	2700	
Heating Capacity		W	3000	
Cooling Power Input		W	670	
Heating Power Input		W	680	
Cooling Current Input		A	3.1	
Heating Current Input		A	3.2	
Rated Input		W	1400	
Rated Cooling Current		A	6.0	
Rated Heating Current		A	6.2	
Air Flow Volume		m <sup>3</sup> /h	610/570/540/470/440/420/390/180	
Dehumidifying Volume		L/h	0.80	
EER		W/W	4.03	
COP		W/W	4.41	
SEER			8.5	
SCOP(Average/WarmerColder)			4.6/5.7/3.5	
Application Area		m <sup>2</sup>	12-18	
Indoor Unit	Model		1.GWH09AUCXB-K6DNA1A/I 2.GWH09AUCXB-K6DNA2A/I	
	Product Code		1.CB575N00300/CB575N00302/CB575N00303/CB575N00304/CB575N00306 2.CB597N00400/CB597N00402	
	Fan Type		Cross-flow	
	Fan Diameter Length(DXL)		mm	Φ98×633.5
	Cooling Speed		r/min	1200/1100 /1050/950/800/700/650/500
	Heating Speed		r/min	1200/1100 /1040/950/900/880/850
	Fan Motor Power Output		W	15
	Fan Motor RLA		A	0.22
	Fan Motor Capacitor		μF	/
	Heater Power Input		W	25
	Evaporator Form			Aluminum Fin-copper Tube
	Evaporator Pipe Diameter		mm	Φ5
	Evaporator Row-fin Gap		mm	2-1.4
	Evaporator Coil Length (LXDXW)		mm	635×22.8×306.3
	Swing Motor Model			MP24HF/MP24AK/MP24BA
	Swing Motor Power Output		W	1.5/1.5/1.5
	Fuse Current		A	3.15
	Sound Pressure Level		dB (A)	Cooling:38/37/34/31/26/23/22/19 Heating:39/37/34/31/30/29/28
	Sound Power Level		dB (A)	Cooling:58/51/48/45/40/37/36/33 Heating:58/51/48/45/44/43/42
	Dimension (WXHxD)		mm	837×293×200
	Dimension of Carton Box (LXWXH)		mm	891×357×261
Dimension of Package (LXWXH)		mm	896×373×272	
Net Weight		kg	9.5	
Gross Weight		kg	11.5	



Outdoor Unit	Outdoor Unit Model		GWH09AUCXB-K6DNA1A/O(LCLH)	
	Outdoor Unit Product Code		CB575W00300	
	Compressor Manufacturer		ZHUHAI LANDA COMPRESSOR CO.,LTD	
	Compressor Model		QXF-A082zC170	
	Compressor Oil		ZE-G;ES RB68GX or equivalent	
	Compressor Type		Rotary	
	Compressor LRA.	A		15.00
	Compressor RLA	A		2.56
	Compressor Power Input	W		756.6
	Compressor Overload Protector			/
	Throttling Method			Capillary
	Set Temperature Range	°C		16~30
	Cooling Operation Ambient Temperature Range	°C		-15~50
	Heating Operation Ambient Temperature Range	°C		-25~30
	Condenser Form			Aluminum Fin-copper Tube
	Condenser Pipe Diameter	mm		Φ7
	Condenser Rows-fin Gap	mm		1-1.2
	Condenser Coil Length (LXDXW)	mm		666×19.05×527
	Fan Motor Speed	rpm		850
	Fan Motor Power Output	W		30
	Fan Motor RLA	A		0.40
	Fan Motor Capacitor	μF		/
	Outdoor Unit Air Flow Volume	m <sup>3</sup> /h		1950
	Fan Type			Axial-flow
	Fan Diameter	mm		Φ400
	Defrosting Method			Automatic Defrosting
	Climate Type			T1
	Isolation			I
	Moisture Protection			IPX4
	Permissible Excessive Operating Pressure for the Discharge Side	MPa		4.3
	Permissible Excessive Operating Pressure for the Suction Side	MPa		2.5
	Sound Pressure Level	dB (A)		50
	Sound Power Level	dB (A)		61
Dimension(WXHXD)	mm		732×555×330	
Dimension of Carton Box (LXWXH)	mm		791×373×590	
Dimension of Package(LXWXH)	mm		794×376×615	
Net Weight	kg		25	
Gross Weight	kg		27.5	
Refrigerant			R32	
Refrigerant Charge	kg		0.53	
Connection Pipe	Connection Pipe Length	m	5	
	Connection Pipe Gas Additional Charge	g/m	16	
	Outer Diameter Liquid Pipe		1/4"	
	Outer Diameter Gas Pipe		3/8"	
	Max Distance Height	m	10	
	Max Distance Length	m	15	
Note: The connection pipe applies metric diameter.				

The above data is subject to change without notice. Please refer to the nameplate of the unit.

Model			1.GWH09AUCXB-K6DNA1A 2.GWH09AUCXB-K6DNA2A
Product Code			1.CB575000301/CB575000305/CB575000306/CB575000308/CB575000309/ CB575000310 2.CB597000401/CB597000402
Power Supply	Rated Voltage	V~	220-240
	Rated Frequency	Hz	50
	Phases		1
Power Supply Mode			Outdoor
Cooling Capacity		W	2700
Heating Capacity		W	3000
Cooling Power Input		W	670
Heating Power Input		W	680
Cooling Current Input		A	3.1
Heating Current Input		A	3.2
Rated Input		W	1400
Rated Cooling Current		A	6.0
Rated Heating Current		A	6.2
Air Flow Volume		m <sup>3</sup> /h	610/570/540/470/440/420/390/180
Dehumidifying Volume		L/h	0.80
EER		W/W	4.03
COP		W/W	4.41
SEER			8.5
SCOP(Average/WarmerColder)			4.6/5.7/3.5
Application Area		m <sup>2</sup>	12-18
Indoor Unit	Model		1.GWH09AUCXB-K6DNA1A/I 2.GWH09AUCXB-K6DNA2A/I
	Product Code		1.CB575N00300/CB575N00302/CB575N00306/CB575N00308/ CB575N00309/CB575N00310 2.CB597N00400/CB597N00402
	Fan Type		Cross-flow
	Fan Diameter Length(DXL)	mm	Φ98×633.5
	Cooling Speed	r/min	1200/1100 /1050/950/800/700/650/500
	Heating Speed	r/min	1200/1100 /1040/950/900/880/850
	Fan Motor Power Output	W	15
	Fan Motor RLA	A	0.22
	Fan Motor Capacitor	μF	/
	Heater Power Input	W	25
	Evaporator Form		Aluminum Fin-copper Tube
	Evaporator Pipe Diameter	mm	Φ5
	Evaporator Row-fin Gap	mm	2-1.4
	Evaporator Coil Length (LXDXW)	mm	635×22.8×306.3
	Swing Motor Model		MP24HF/MP24AK/MP24BA
	Swing Motor Power Output	W	1.5/1.5/1.5
	Fuse Current	A	3.15
	Sound Pressure Level	dB (A)	Cooling:38/37/34/31/26/23/22/19 Heating:39/37/34/31/30/29/28
	Sound Power Level	dB (A)	Cooling:58/51/48/45/40/37/36/33 Heating:58/51/48/45/44/43/42
	Dimension (WXHXD)	mm	837×293×200
	Dimension of Carton Box (LXWXH)	mm	891×357×261
Dimension of Package (LXWXH)	mm	896×373×272	
Net Weight	kg	9.5	
Gross Weight	kg	11.5	

Outdoor Unit	Outdoor Unit Model		GWH09AUCXB-K6DNA1A/O(LC)	
	Outdoor Unit Product Code		CB575W00301	
	Compressor Manufacturer		ZHUHAI LANDA COMPRESSOR CO.,LTD	
	Compressor Model		QXF-A082zC170	
	Compressor Oil		ZE-G;ES RB68GX or equivalent	
	Compressor Type		Rotary	
	Compressor LRA.	A		15.00
	Compressor RLA	A		2.56
	Compressor Power Input	W		756.6
	Compressor Overload Protector			/
	Throttling Method			Capillary
	Set Temperature Range	°C		16~30
	Cooling Operation Ambient Temperature Range	°C		-15~50
	Heating Operation Ambient Temperature Range	°C		-15~30
	Condenser Form			Aluminum Fin-copper Tube
	Condenser Pipe Diameter	mm		Φ7
	Condenser Rows-fin Gap	mm		1-1.2
	Condenser Coil Length (LXDXW)	mm		666×19.05×527
	Fan Motor Speed	rpm		850
	Fan Motor Power Output	W		30
	Fan Motor RLA	A		0.40
	Fan Motor Capacitor	μF		/
	Outdoor Unit Air Flow Volume	m <sup>3</sup> /h		1950
	Fan Type			Axial-flow
	Fan Diameter	mm		Φ400
	Defrosting Method			Automatic Defrosting
	Climate Type			T1
	Isolation			I
	Moisture Protection			IPX4
	Permissible Excessive Operating Pressure for the Discharge Side	MPa		4.3
	Permissible Excessive Operating Pressure for the Suction Side	MPa		2.5
	Sound Pressure Level	dB (A)		50
	Sound Power Level	dB (A)		61
Dimension(WXHxD)	mm		732×555×330	
Dimension of Carton Box (LXWXH)	mm		791×373×590	
Dimension of Package(LXWXH)	mm		794×376×615	
Net Weight	kg		25	
Gross Weight	kg		27.5	
Refrigerant			R32	
Refrigerant Charge	kg		0.53	
Connection Pipe	Connection Pipe Length	m	5	
	Connection Pipe Gas Additional Charge	g/m	16	
	Outer Diameter Liquid Pipe		1/4"	
	Outer Diameter Gas Pipe		3/8"	
	Max Distance Height	m	10	
	Max Distance Length	m	15	
	Note: The connection pipe applies metric diameter.			

The above data is subject to change without notice. Please refer to the nameplate of the unit.

Model			1.GWH12AUCXB-K6DNA1A 2.GWH12AUCXB-K6DNA2A
Product Code			1.CB575000200/CB575000202/CB575000203/CB575000204/CB575000207 2.CB597000100/CB597000102/CB597000103
Power Supply	Rated Voltage	V~	220-240
	Rated Frequency	Hz	50
	Phases		1
Power Supply Mode			Outdoor
Cooling Capacity		W	3510
Heating Capacity		W	3810
Cooling Power Input		W	989
Heating Power Input		W	977
Cooling Current Input		A	4.4
Heating Current Input		A	4.4
Rated Input		W	1650
Rated Cooling Current		A	6.2
Rated Heating Current		A	7.4
Air Flow Volume		m <sup>3</sup> /h	680/620/560/490/450/420/390/220
Dehumidifying Volume		L/h	1.40
EER		W/W	3.55
COP		W/W	3.90
SEER			7.2
SCOP(Average/WarmerColder)			4.1/5.2/3.1
Application Area		m <sup>2</sup>	16-24
Indoor Unit	Model		1.GWH12AUCXB-K6DNA1A/I 2.GWH12AUCXB-K6DNA2A/I
	Product Code		1.CB575N00200/CB575N00202/CB575N00203/CB575N00204/CB575N00206 2.CB597N00100/CB597N00102/CB597N00103
	Fan Type		Cross-flow
	Fan Diameter Length(DXL)	mm	Φ98×630
	Cooling Speed	r/min	1300/1200/1100/1000/900/800/750/500
	Heating Speed	r/min	1300/1200/1100/1000/900/850/800
	Fan Motor Power Output	W	15
	Fan Motor RLA	A	0.20
	Fan Motor Capacitor	μF	/
	Heater Power Input	W	25
	Evaporator Form		Aluminum Fin-copper Tube
	Evaporator Pipe Diameter	mm	Φ5
	Evaporator Row-fin Gap	mm	2-1.4
	Evaporator Coil Length (LXD <sub>X</sub> W)	mm	634×22.8×304.8
	Swing Motor Model		MP24BA/MP24AK/MP24HF
	Swing Motor Power Output	W	1.5/1.5/1.5
	Fuse Current	A	3.15
	Sound Pressure Level	dB (A)	Cooling:41/38/36/33/30/27/25/19 Heating:41/38/36/33/29/27/26
	Sound Power Level	dB (A)	Cooling:60/52/50/47/44/41/39/33 Heating:55/52/50/47/43/41/40
	Dimension (WXH <sub>X</sub> D)	mm	837×293×200
	Dimension of Carton Box (LXWXH)	mm	891×357×261
	Dimension of Package (LXWXH)	mm	896×373×272
	Net Weight	kg	9.5
Gross Weight	kg	11.5	

Outdoor Unit	Outdoor Unit Model		GWH12AUCXB-K6DNA1A/O(LCLH)	
	Outdoor Unit Product Code		CB575W00200	
	Compressor Manufacturer		ZHUHAI LANDA COMPRESSOR CO., LTD	
	Compressor Model		FTz-AN108ACBD	
	Compressor Oil		FW68DA or equivalent	
	Compressor Type		Rotary	
	Compressor LRA.	A		/
	Compressor RLA	A		4.40
	Compressor Power Input	W		/
	Compressor Overload Protector			/
	Throttling Method			Electron expansion valve
	Set Temperature Range	°C		16~30
	Cooling Operation Ambient Temperature Range	°C		-15~50
	Heating Operation Ambient Temperature Range	°C		-25~30
	Condenser Form			Aluminum Fin-copper Tube
	Condenser Pipe Diameter	mm		Φ7.94
	Condenser Rows-fin Gap	mm		1-1.2
	Condenser Coil Length (LXDXW)	mm		666×19.05×527
	Fan Motor Speed	rpm		900
	Fan Motor Power Output	W		30
	Fan Motor RLA	A		0.40
	Fan Motor Capacitor	μF		/
	Outdoor Unit Air Flow Volume	m <sup>3</sup> /h		1950
	Fan Type			Axial-flow
	Fan Diameter	mm		Φ400
	Defrosting Method			Automatic Defrosting
	Climate Type			T1
	Isolation			I
	Moisture Protection			IPX4
	Permissible Excessive Operating Pressure for the Discharge Side	MPa		4.3
	Permissible Excessive Operating Pressure for the Suction Side	MPa		2.5
	Sound Pressure Level	dB (A)		52
	Sound Power Level	dB (A)		63
Dimension(WXHxD)	mm		732×555×330	
Dimension of Carton Box (LXWXH)	mm		791×373×590	
Dimension of Package(LXWXH)	mm		794×376×615	
Net Weight	kg		25.5	
Gross Weight	kg		28	
Refrigerant			R32	
Refrigerant Charge	kg		0.57	
Connection Pipe	Connection Pipe Length	m	5	
	Connection Pipe Gas Additional Charge	g/m	16	
	Outer Diameter Liquid Pipe		1/4"	
	Outer Diameter Gas Pipe		3/8"	
	Max Distance Height	m	10	
	Max Distance Length	m	15	
Note: The connection pipe applies metric diameter.				

The above data is subject to change without notice. Please refer to the nameplate of the unit.

Model			1.GWH12AUCXB-K6DNA1A 2.GWH12AUCXB-K6DNA2A	
Product Code			1.CB575000201/CB575000205/CB575000206/CB575000208/ CB575000209/CB575000210 2.CB597000101	
Power Supply	Rated Voltage	V~	220-240	
	Rated Frequency	Hz	50	
	Phases		1	
Power Supply Mode			Outdoor	
Cooling Capacity		W	3510	
Heating Capacity		W	3810	
Cooling Power Input		W	989	
Heating Power Input		W	977	
Cooling Current Input		A	4.4	
Heating Current Input		A	4.4	
Rated Input		W	1650	
Rated Cooling Current		A	6.2	
Rated Heating Current		A	7.4	
Air Flow Volume		m <sup>3</sup> /h	680/620/560/490/450/420/390/220	
Dehumidifying Volume		L/h	1.40	
EER		W/W	3.55	
COP		W/W	3.90	
SEER			7.2	
SCOP(Average/WarmerColder)			4.1/5.2/3.1	
Application Area		m <sup>2</sup>	16-24	
Indoor Unit	Model		1.GWH12AUCXB-K6DNA1A/I 2.GWH12AUCXB-K6DNA2A/I	
	Product Code		1.CB575N00200/CB575N00202/CB575N00206/CB575N00203/ CB575N00204/CB575N00210 2.CB597N00100	
	Fan Type		Cross-flow	
	Fan Diameter Length(DXL)		mm	Φ98×630
	Cooling Speed		r/min	1300/1200/1100/1000/900/800/750/500
	Heating Speed		r/min	1300/1200/1100/1000/900/850/800
	Fan Motor Power Output		W	15
	Fan Motor RLA		A	0.20
	Fan Motor Capacitor		μF	/
	Heater Power Input		W	25
	Evaporator Form			Aluminum Fin-copper Tube
	Evaporator Pipe Diameter		mm	Φ5
	Evaporator Row-fin Gap		mm	2-1.4
	Evaporator Coil Length (LXDXW)		mm	634×22.8×304.8
	Swing Motor Model			MP24BA/MP24AK/MP24HF
	Swing Motor Power Output		W	1.5/1.5/1.5
	Fuse Current		A	3.15
	Sound Pressure Level		dB (A)	Cooling:41/38/36/33/30/27/25/19 Heating:41/38/36/33/29/27/26
	Sound Power Level		dB (A)	Cooling:60/52/50/47/44/41/39/33 Heating:55/52/50/47/43/41/40
	Dimension (WXHxD)		mm	837×293×200
	Dimension of Carton Box (LXWXH)		mm	891×357×261
	Dimension of Package (LXWXH)		mm	896×373×272
	Net Weight		kg	9.5
Gross Weight		kg	11.5	

Outdoor Unit	Outdoor Unit Model		GWH12AUCXB-K6DNA1A/O(LC)
	Outdoor Unit Product Code		CB575W00201
	Compressor Manufacturer		ZHUHAI LANDA COMPRESSOR CO., LTD
	Compressor Model		FTz-AN108ACBD
	Compressor Oil		FW68DA or equivalent
	Compressor Type		Rotary
	Compressor LRA.	A	/
	Compressor RLA	A	4.40
	Compressor Power Input	W	/
	Compressor Overload Protector		/
	Throttling Method		Electron expansion valve
	Set Temperature Range	°C	16~30
	Cooling Operation Ambient Temperature Range	°C	-15~50
	Heating Operation Ambient Temperature Range	°C	-15~30
	Condenser Form		Aluminum Fin-copper Tube
	Condenser Pipe Diameter	mm	Φ7.94
	Condenser Rows-fin Gap	mm	1-1.2
	Condenser Coil Length (LXDXW)	mm	666×19.05×527
	Fan Motor Speed	rpm	900
	Fan Motor Power Output	W	30
	Fan Motor RLA	A	0.40
	Fan Motor Capacitor	μF	/
	Outdoor Unit Air Flow Volume	m <sup>3</sup> /h	1950
	Fan Type		Axial-flow
	Fan Diameter	mm	Φ400
	Defrosting Method		Automatic Defrosting
	Climate Type		T1
	Isolation		I
	Moisture Protection		IPX4
	Permissible Excessive Operating Pressure for the Discharge Side	MPa	4.3
	Permissible Excessive Operating Pressure for the Suction Side	MPa	2.5
	Sound Pressure Level	dB (A)	52
	Sound Power Level	dB (A)	63
Dimension(WXHxD)	mm	732×555×330	
Dimension of Carton Box (LXWXH)	mm	791×373×590	
Dimension of Package(LXWXH)	mm	794×376×615	
Net Weight	kg	25.5	
Gross Weight	kg	28	
Refrigerant		R32	
Refrigerant Charge	kg	0.57	
Connection Pipe	Connection Pipe Length	m	5
	Connection Pipe Gas Additional Charge	g/m	16
	Outer Diameter Liquid Pipe		1/4"
	Outer Diameter Gas Pipe		3/8"
	Max Distance Height	m	10
	Max Distance Length	m	15
Note: The connection pipe applies metric diameter.			

The above data is subject to change without notice. Please refer to the nameplate of the unit.

Model		GWH12AUCXD-K6DNA1C		
Product Code		CB575000700/CB575000705/CB575000704		
Power Supply	Rated Voltage	V~	220-240	
	Rated Frequency	Hz	50	
	Phases		1	
Power Supply Mode		Outdoor		
Cooling Capacity		W	3510	
Heating Capacity		W	3810	
Cooling Power Input		W	877	
Heating Power Input		W	952	
Cooling Current Input		A	4.1	
Heating Current Input		A	4.5	
Rated Input		W	1800	
Rated Cooling Current		A	6.5	
Rated Heating Current		A	8.0	
Air Flow Volume		m <sup>3</sup> /h	720/600/570/530/500/460/430	
Dehumidifying Volume		L/h	1.40	
EER		W/W	4.00	
COP		W/W	4.00	
SEER			8.5	
SCOP(Average/WarmerColder)			4.6/5.6/3.6	
Application Area		m <sup>2</sup>	16-24	
Indoor Unit	Model		GWH12AUCXD-K6DNA1C/I	
	Product Code		CB575N00700/CB575N00705/CB575N00704	
	Fan Type		Cross-flow	
	Fan Diameter Length(DXL)		mm	Φ98×630
	Cooling Speed		r/min	1400/1200/1120/1050/980/920/750/500
	Heating Speed		r/min	1400/1200/1140/1080/1020/960/900
	Fan Motor Power Output		W	15
	Fan Motor RLA		A	0.2
	Fan Motor Capacitor		μF	/
	Heater Power Input		W	/
	Evaporator Form			Aluminum Fin-copper Tube
	Evaporator Pipe Diameter		mm	Φ5
	Evaporator Row-fin Gap		mm	2-1.4
	Evaporator Coil Length (LXDXW)		mm	634×22.8×304.8
	Swing Motor Model			MP24BA/MP24AK/MP24HF
	Swing Motor Power Output		W	1.5/1.5/1.5
	Fuse Current		A	3.15
	Sound Pressure Level		dB (A)	Cooling:43/39/37/35/32/30/24/19 Heating:44/39/37/35/33/31/29
	Sound Power Level		dB (A)	Cooling:60/53/51/49/46/44/38/33 Heating:60/53/51/49/47/45/43
	Dimension (WXHxD)		mm	837×293×200
Dimension of Carton Box (LXWXH)		mm	891×357×261	
Dimension of Package (LXWXH)		mm	896×373×272	
Net Weight		kg	9.5	
Gross Weight		kg	11.5	



Outdoor Unit	Outdoor Unit Model		GWH12AUCXD-K6DNA1C/O(LCLH)	
	Outdoor Unit Product Code		CB575W00700	
	Compressor Manufacturer		ZHUHAI LANDA COMPRESSOR CO., LTD	
	Compressor Model		QXF-A098zE170	
	Compressor Oil		ZE-GLES RB68GX or equivalent	
	Compressor Type		Rotary	
	Compressor LRA.	A		/
	Compressor RLA	A		3.9
	Compressor Power Input	W		/
	Compressor Overload Protector			/
	Throttling Method			Electron expansion valve
	Set Temperature Range	°C		16~30
	Cooling Operation Ambient Temperature Range	°C		-15~50
	Heating Operation Ambient Temperature Range	°C		-25~30
	Condenser Form			Aluminum Fin-copper Tube
	Condenser Pipe Diameter	mm		Φ7
	Condenser Rows-fin Gap	mm		2-1.4
	Condenser Coil Length (LXDXW)	mm		761.5×38.1×528
	Fan Motor Speed	rpm		850
	Fan Motor Power Output	W		30
	Fan Motor RLA	A		0.4
	Fan Motor Capacitor	μF		/
	Outdoor Unit Air Flow Volume	m <sup>3</sup> /h		2200
	Fan Type			Axial-flow
	Fan Diameter	mm		Φ420
	Defrosting Method			Automatic Defrosting
	Climate Type			T1
	Isolation			I
	Moisture Protection			IPX4
	Permissible Excessive Operating Pressure for the Discharge Side	MPa		4.3
	Permissible Excessive Operating Pressure for the Suction Side	MPa		2.5
	Sound Pressure Level	dB (A)		53
	Sound Power Level	dB (A)		64
Dimension(WXHxD)	mm		802×555×350	
Dimension of Carton Box (LXWXH)	mm		869×395×594	
Dimension of Package(LXWXH)	mm		872×398×620	
Net Weight	kg		30	
Gross Weight	kg		32.5	
Refrigerant			R32	
Refrigerant Charge	kg		0.8	
Connection Pipe	Connection Pipe Length	m	5	
	Connection Pipe Gas Additional Charge	g/m	16	
	Outer Diameter Liquid Pipe		1/4"	
	Outer Diameter Gas Pipe		3/8"	
	Max Distance Height	m	10	
	Max Distance Length	m	20	
Note: The connection pipe applies metric diameter.				

The above data is subject to change without notice. Please refer to the nameplate of the unit.

Model			1.GWH12AUCXD-K6DNA1C 2.GWH12AUCXD-K6DNA2C
Product Code			1.CB575000701/CB575000702/CB575000703 2.CB597000601
Power Supply	Rated Voltage	V~	220-240
	Rated Frequency	Hz	50
	Phases		1
Power Supply Mode			Outdoor
Cooling Capacity		W	3510
Heating Capacity		W	3810
Cooling Power Input		W	877
Heating Power Input		W	952
Cooling Current Input		A	4.1
Heating Current Input		A	4.5
Rated Input		W	1800
Rated Cooling Current		A	6.5
Rated Heating Current		A	8.0
Air Flow Volume		m <sup>3</sup> /h	720/600/570/530/500/460/430/320
Dehumidifying Volume		L/h	1.40
EER		W/W	4.00
COP		W/W	4.00
SEER			8.5
SCOP(Average/WarmerColder)			4.6/5.6/3.6
Application Area		m <sup>2</sup>	16-24
Indoor Unit	Model		1.GWH12AUCXD-K6DNA1C/I 2.GWH12AUCXD-K6DNA2C/I
	Product Code		1.CB575N00700/CB575N00702/CB575N00703 2.CB597N00600
	Fan Type		Cross-flow
	Fan Diameter Length(DXL)		mm Φ98×630
	Cooling Speed		r/min 1400/1200/1120/1050/980/920/750/500
	Heating Speed		r/min 1400/1200/1140/1080/1020/960/900
	Fan Motor Power Output		W 15
	Fan Motor RLA		A 0.2
	Fan Motor Capacitor		μF /
	Heater Power Input		W /
	Evaporator Form		Aluminum Fin-copper Tube
	Evaporator Pipe Diameter		mm Φ5
	Evaporator Row-fin Gap		mm 2-1.4
	Evaporator Coil Length (LXD <sub>X</sub> W)		mm 634×22.8×304.8
	Swing Motor Model		MP24BA/MP24AK/MP24HF
	Swing Motor Power Output		W 1.5/1.5/1.5
	Fuse Current		A 3.15
	Sound Pressure Level		dB (A) Cooling:43/39/37/35/32/30/24/19 Heating:44/39/37/35/33/31/29
	Sound Power Level		dB (A) Cooling:60/53/51/49/46/44/38/33 Heating:60/53/51/49/47/45/43
	Dimension (WXHXD)		mm 837×293×200
Dimension of Carton Box (LXWXH)		mm 891×357×261	
Dimension of Package (LXWXH)		mm 896×373×272	
Net Weight		kg 9.5	
Gross Weight		kg 11.5	

Outdoor Unit	Outdoor Unit Model		GWH12AUCXD-K6DNA1C/O(LC)
	Outdoor Unit Product Code		CB575W00701
	Compressor Manufacturer		ZHUHAI LANDA COMPRESSOR CO., LTD
	Compressor Model		QXF-A098zE170
	Compressor Oil		ZE-GLES RB68GX or equivalent
	Compressor Type		Rotary
	Compressor LRA.	A	/
	Compressor RLA	A	3.9
	Compressor Power Input	W	/
	Compressor Overload Protector		/
	Throttling Method		Electron expansion valve
	Set Temperature Range	°C	16~30
	Cooling Operation Ambient Temperature Range	°C	-15~50
	Heating Operation Ambient Temperature Range	°C	-15~30
	Condenser Form		Aluminum Fin-copper Tube
	Condenser Pipe Diameter	mm	Φ7
	Condenser Rows-fin Gap	mm	2-1.4
	Condenser Coil Length (LXDXW)	mm	761.5×38.1×528
	Fan Motor Speed	rpm	850
	Fan Motor Power Output	W	30
	Fan Motor RLA	A	0.4
	Fan Motor Capacitor	μF	/
	Outdoor Unit Air Flow Volume	m <sup>3</sup> /h	2200
	Fan Type		Axial-flow
	Fan Diameter	mm	Φ420
	Defrosting Method		Automatic Defrosting
	Climate Type		T1
	Isolation		I
	Moisture Protection		IPX4
	Permissible Excessive Operating Pressure for the Discharge Side	MPa	4.3
	Permissible Excessive Operating Pressure for the Suction Side	MPa	2.5
	Sound Pressure Level	dB (A)	53
	Sound Power Level	dB (A)	64
Dimension(WXHxD)	mm	802×555×350	
Dimension of Carton Box (LXWXH)	mm	869×395×594	
Dimension of Package(LXWXH)	mm	872×398×620	
Net Weight	kg	30	
Gross Weight	kg	32.5	
Refrigerant		R32	
Refrigerant Charge	kg	0.8	
Connection Pipe	Connection Pipe Length	m	5
	Connection Pipe Gas Additional Charge	g/m	16
	Outer Diameter Liquid Pipe		1/4"
	Outer Diameter Gas Pipe		3/8"
	Max Distance Height	m	10
	Max Distance Length	m	20
Note: The connection pipe applies metric diameter.			

The above data is subject to change without notice. Please refer to the nameplate of the unit.

Model			1.GWH18AUDXD-K6DNA1A 2.GWH18AUDXD-K6DNA2A
Product Code			1.CB575000100/CB575000102/CB575000103/CB575000104/CB575000107 2.CB597000200/CB597000204/CB597000203
Power Supply	Rated Voltage	V~	220-240
	Rated Frequency	Hz	50
	Phases		1
Power Supply Mode			Outdoor
Cooling Capacity		W	5300
Heating Capacity		W	5350
Cooling Power Input		W	1582
Heating Power Input		W	1393
Cooling Current Input		A	7.2
Heating Current Input		A	6.3
Rated Input		W	2350
Rated Cooling Current		A	10
Rated Heating Current		A	10.5
Air Flow Volume		m <sup>3</sup> /h	1000/850/760/650/580/520/450
Dehumidifying Volume		L/h	1.90
EER		W/W	3.35
COP		W/W	3.84
SEER			7.3
SCOP(Average/WarmerColder)			4.2/5.7/3.5
Application Area		m <sup>2</sup>	23-34
Indoor Unit	Model		1.GWH18AUDXD-K6DNA1A/I 2.GWH18AUDXD-K6DNA2A/I
	Product Code		1.CB575N00100/CB575N00102/CB575N00103/CB575N00104/CB575N00105 2.CB597N00200/CB597N00204/CB597N00203
	Fan Type		Cross-flow
	Fan Diameter Length(DXL)	mm	Φ106×739
	Cooling Speed	r/min	1250/1150/1030/960/800/700/650/500
	Heating Speed	r/min	1300/1150/1040/950/900/880/800
	Fan Motor Power Output	W	45
	Fan Motor RLA	A	0.25
	Fan Motor Capacitor	μF	/
	Heater Power Input	W	/
	Evaporator Form		Aluminum Fin-copper Tube
	Evaporator Pipe Diameter	mm	Φ5
	Evaporator Row-fin Gap	mm	2-1.3
	Evaporator Coil Length (LXDXW)	mm	745×22.8×342.9
	Swing Motor Model		MP24AK/MP24BA/MP24HF
	Swing Motor Power Output	W	1.5/1.5 /1.5
	Fuse Current	A	3.15
	Sound Pressure Level	dB (A)	Cooling:45/42/40/37/34/29/26/23 Heating:48/44/42/37/36/35/32
	Sound Power Level	dB (A)	Cooling:60/55/53/50/47/42/39/36 Heating:60/57/55/50/49/48/45
	Dimension (WXHXD)	mm	993×311×222
	Dimension of Carton Box (LXWXH)	mm	1050×377×288
Dimension of Package (LXWXH)	mm	1055×385×298	
Net Weight	kg	12.5	
Gross Weight	kg	15	

Outdoor Unit	Outdoor Unit Model		GWH18AUDXD-K6DNA1A/O(LCLH)	
	Outdoor Unit Product Code		CB575W00100	
	Compressor Manufacturer		ZHUHAI LANDA COMPRESSOR CO.,LTD	
	Compressor Model		QXF-A120zH170A	
	Compressor Oil		FW68DA or equivalent	
	Compressor Type		Rotary	
	Compressor LRA.	A		18.00
	Compressor RLA	A		5.00
	Compressor Power Input	W		1096
	Compressor Overload Protector			HPC115/95U1/KSD115°C
	Throttling Method			Electron expansion valve
	Set Temperature Range	°C		16~30
	Cooling Operation Ambient Temperature Range	°C		-15~50
	Heating Operation Ambient Temperature Range	°C		-25~30
	Condenser Form			Aluminum Fin-copper Tube
	Condenser Pipe Diameter	mm		Φ7
	Condenser Rows-fin Gap	mm		2-1.4
	Condenser Coil Length (LXDXW)	mm		895×38.1×528
	Fan Motor Speed	rpm		880
	Fan Motor Power Output	W		30
	Fan Motor RLA	A		0.40
	Fan Motor Capacitor	μF		/
	Outdoor Unit Air Flow Volume	m <sup>3</sup> /h		2200
	Fan Type			Axial-flow
	Fan Diameter	mm		Φ420
	Defrosting Method			Automatic Defrosting
	Climate Type			T1
	Isolation			I
	Moisture Protection			IPX4
	Permissible Excessive Operating Pressure for the Discharge Side	MPa		4.3
	Permissible Excessive Operating Pressure for the Suction Side	MPa		2.5
	Sound Pressure Level	dB (A)		56
	Sound Power Level	dB (A)		65
Dimension(WXHXD)	mm		802×555×350	
Dimension of Carton Box (LXWXH)	mm		869×395×594	
Dimension of Package(LXWXH)	mm		872×398×620	
Net Weight	kg		31.5	
Gross Weight	kg		34	
Refrigerant			R32	
Refrigerant Charge	kg		0.85	
Connection Pipe	Connection Pipe Length	m	5	
	Connection Pipe Gas Additional Charge	g/m	16	
	Outer Diameter Liquid Pipe		1/4"	
	Outer Diameter Gas Pipe		1/2"	
	Max Distance Height	m	10	
	Max Distance Length	m	25	
	Note: The connection pipe applies metric diameter.			

The above data is subject to change without notice. Please refer to the nameplate of the unit.

Model			1.GWH18AUDXD-K6DNA1A 2.GWH18AUDXD-K6DNA2A	
Product Code			1.CB575000101/CB575000105/CB575000106/CB575000108/ CB575000109/CB575000110 2.CB597000202	
Power Supply	Rated Voltage	V~	220-240	
	Rated Frequency	Hz	50	
	Phases		1	
Power Supply Mode			Outdoor	
Cooling Capacity		W	5300	
Heating Capacity		W	5350	
Cooling Power Input		W	1582	
Heating Power Input		W	1393	
Cooling Current Input		A	7.2	
Heating Current Input		A	6.3	
Rated Input		W	2350	
Rated Cooling Current		A	10	
Rated Heating Current		A	10.5	
Air Flow Volume		m <sup>3</sup> /h	1000/850/760/650/580/520/450	
Dehumidifying Volume		L/h	1.90	
EER		W/W	3.35	
COP		W/W	3.84	
SEER			7.3	
SCOP(Average/WarmerColder)			4.2/5.7/3.5	
Application Area		m <sup>2</sup>	23-34	
Indoor Unit	Model		1.GWH18AUDXD-K6DNA1A/I 2.GWH18AUDXD-K6DNA2A/I	
	Product Code		1.CB575N00100/CB575N00102/CB575N00105/CB575N00104/ CB575N00103/CB575N00110 2.CB597N00200	
	Fan Type		Cross-flow	
	Fan Diameter Length(DXL)		mm	Φ106×739
	Cooling Speed		r/min	1250/1150/1030/960/800/700/650/500
	Heating Speed		r/min	1300/1150/1040/950/900/880/800
	Fan Motor Power Output		W	45
	Fan Motor RLA		A	0.25
	Fan Motor Capacitor		μF	/
	Heater Power Input		W	/
	Evaporator Form			Aluminum Fin-copper Tube
	Evaporator Pipe Diameter		mm	Φ5
	Evaporator Row-fin Gap		mm	2-1.3
	Evaporator Coil Length (LXD <sub>X</sub> W)		mm	745×22.8×342.9
	Swing Motor Model			MP24AK/MP24BA/MP24HF
	Swing Motor Power Output		W	1.5/1.5 /1.5
	Fuse Current		A	3.15
	Sound Pressure Level		dB (A)	Cooling:45/42/40/37/34/29/26/23 Heating:48/44/42/37/36/35/32
	Sound Power Level		dB (A)	Cooling:60/55/53/50/47/42/39/36 Heating:60/57/55/50/49/48/45
	Dimension (WXH <sub>X</sub> D)		mm	993×311×222
Dimension of Carton Box (LXWXH)		mm	1050×377×288	
Dimension of Package (LXWXH)		mm	1055×385×298	
Net Weight		kg	12.5	
Gross Weight		kg	15	

Outdoor Unit	Outdoor Unit Model		GWH18AUDXD-K6DNA1A/O(LC)	
	Outdoor Unit Product Code		CB575W00101	
	Compressor Manufacturer		ZHUHAI LANDA COMPRESSOR CO.,LTD	
	Compressor Model		QXF-A120zH170A	
	Compressor Oil		FW68DA or equivalent	
	Compressor Type		Rotary	
	Compressor LRA.	A		18.00
	Compressor RLA	A		5.00
	Compressor Power Input	W		1096
	Compressor Overload Protector			HPC115/95U1/KSD115°C
	Throttling Method			Electron expansion valve
	Set Temperature Range	°C		16~30
	Cooling Operation Ambient Temperature Range	°C		-15~50
	Heating Operation Ambient Temperature Range	°C		-15~30
	Condenser Form			Aluminum Fin-copper Tube
	Condenser Pipe Diameter	mm		Φ7
	Condenser Rows-fin Gap	mm		2-1.4
	Condenser Coil Length (LXDXW)	mm		895×38.1×528
	Fan Motor Speed	rpm		880
	Fan Motor Power Output	W		30
	Fan Motor RLA	A		0.40
	Fan Motor Capacitor	μF		/
	Outdoor Unit Air Flow Volume	m <sup>3</sup> /h		2200
	Fan Type			Axial-flow
	Fan Diameter	mm		Φ420
	Defrosting Method			Automatic Defrosting
	Climate Type			T1
	Isolation			I
	Moisture Protection			IPX4
	Permissible Excessive Operating Pressure for the Discharge Side	MPa		4.3
	Permissible Excessive Operating Pressure for the Suction Side	MPa		2.5
	Sound Pressure Level	dB (A)		56
	Sound Power Level	dB (A)		65
Dimension(WXHxD)	mm		802×555×350	
Dimension of Carton Box (LXWXH)	mm		869×395×594	
Dimension of Package(LXWXH)	mm		872×398×620	
Net Weight	kg		31.5	
Gross Weight	kg		34	
Refrigerant			R32	
Refrigerant Charge	kg		0.85	
Connection Pipe	Connection Pipe Length	m	5	
	Connection Pipe Gas Additional Charge	g/m	16	
	Outer Diameter Liquid Pipe		1/4"	
	Outer Diameter Gas Pipe		1/2"	
	Max Distance Height	m	10	
	Max Distance Length	m	25	
	Note: The connection pipe applies metric diameter.			

The above data is subject to change without notice. Please refer to the nameplate of the unit.

Model			1.GWH24AUDXF-K6DNA1A 2.GWH24AUDXF-K6DNA2A
Product Code			1.CB437004700/CB437004702/CB437004703/CB437004704/CB437004707 2.CB597000300/CB597000303
Power Supply	Rated Voltage	V~	220-240
	Rated Frequency	Hz	50
	Phases		1
Power Supply Mode			Outdoor
Cooling Capacity		W	7100
Heating Capacity		W	7300
Cooling Power Input		W	2030
Heating Power Input		W	1870
Cooling Current Input		A	9
Heating Current Input		A	9.3
Rated Input		W	3500
Rated Cooling Current		A	13
Rated Heating Current		A	14
Air Flow Volume		m <sup>3</sup> /h	1000/850/760/580/520/450/400/280
Dehumidifying Volume		L/h	2.40
EER		W/W	3.51
COP		W/W	3.90
SEER			7
SCOP(Average/WarmerColder)			4.30/5.50/3.40
Application Area		m <sup>2</sup>	27-42
Indoor Unit	Model		1.GWH24AUDXF-K6DNA1A/I 2.GWH24AUDXF-K6DNA2A/I
	Product Code		1.CB437N04700/CB437N04702/CB437N04703/CB437N04704/CB437N04706 2.CB597N00300/CB597N00302
	Fan Type		Cross-flow
	Fan Diameter Length(DXL)	mm	Φ106×739
	Cooling Speed	r/min	1400/1200/1120/1050/980/860/750/550
	Heating Speed	r/min	1400/1200/1120/1050/950/850/750
	Fan Motor Power Output	W	45
	Fan Motor RLA	A	0.25
	Fan Motor Capacitor	μF	/
	Heater Power Input	W	/
	Evaporator Form		Aluminum Fin-copper Tube
	Evaporator Pipe Diameter	mm	Φ7
	Evaporator Row-fin Gap	mm	2-1.4
	Evaporator Coil Length (LXDXW)	mm	745×22.8×342.9
	Swing Motor Model		MP24AK/MP24HF/MP24BA
	Swing Motor Power Output	W	1.5/1.5/1.5
	Fuse Current	A	3.15
	Sound Pressure Level	dB (A)	Cooling:48/44/41/40/38/36/33/27 Heating:50/47/43/41/40/36/35
	Sound Power Level	dB (A)	Cooling:65/59/56/55/53/51/48/42 Heating:64/62/58/56/55/51/50
	Dimension (WXHXD)	mm	993×311×222
	Dimension of Carton Box (LXWXH)	mm	1050×377×288
Dimension of Package (LXWXH)	mm	1055×385×298	
Net Weight	kg	13	
Gross Weight	kg	15.5	



Outdoor Unit	Outdoor Unit Model		GWH24AUDXF-K6DNA1A/O(LCLH)	
	Outdoor Unit Product Code		CB437W04700	
	Compressor Manufacturer		ZHUHAI LANDA COMPRESSOR CO.,LTD	
	Compressor Model		QXFS-M180zX170	
	Compressor Oil		/	
	Compressor Type		Rotary	
	Compressor LRA.	A		24.00
	Compressor RLA	A		3.50
	Compressor Power Input	W		1350
	Compressor Overload Protector			HPC 115/95U1 KSD115°C
	Throttling Method			Electron expansion valve
	Set Temperature Range	°C		16~30
	Cooling Operation Ambient Temperature Range	°C		-15~50
	Heating Operation Ambient Temperature Range	°C		-25~30
	Condenser Form			Aluminum Fin-copper Tube
	Condenser Pipe Diameter	mm		Φ7.94
	Condenser Rows-fin Gap	mm		2-1.4
	Condenser Coil Length (LXDXW)	mm		934×38.1×616
	Fan Motor Speed	rpm		800
	Fan Motor Power Output	W		60
	Fan Motor RLA	A		0.65
	Fan Motor Capacitor	μF		/
	Outdoor Unit Air Flow Volume	m <sup>3</sup> /h		3600
	Fan Type			Axial-flow
	Fan Diameter	mm		Φ520
	Defrosting Method			Automatic Defrosting
	Climate Type			T1
	Isolation			I
	Moisture Protection			IPX4
	Permissible Excessive Operating Pressure for the Discharge Side	MPa		4.3
	Permissible Excessive Operating Pressure for the Suction Side	MPa		2.5
	Sound Pressure Level	dB (A)		59
	Sound Power Level	dB (A)		70
Dimension(WXHxD)	mm		958×660×402	
Dimension of Carton Box (LXWXH)	mm		1029×453×715	
Dimension of Package(LXWXH)	mm		1032×456×737	
Net Weight	kg		45	
Gross Weight	kg		49.5	
Refrigerant			R32	
Refrigerant Charge	kg		1.4	
Connection Pipe	Connection Pipe Length	m	5	
	Connection Pipe Gas Additional Charge	g/m	40	
	Outer Diameter Liquid Pipe		1/4"	
	Outer Diameter Gas Pipe		5/8"	
	Max Distance Height	m	10	
	Max Distance Length	m	25	
Note: The connection pipe applies metric diameter.				

The above data is subject to change without notice. Please refer to the nameplate of the unit.

Model			1.GWH24AUDXF-K6DNA1A 2.GWH24AUDXF-K6DNA2A
Product Code			1.CB437004701/CB437004705/CB437004706/CB437004708/ CB437004709/CB437004710 2.CB597000301/CB597000302
Power Supply	Rated Voltage	V~	220-240
	Rated Frequency	Hz	50
	Phases		1
Power Supply Mode			Outdoor
Cooling Capacity		W	7100
Heating Capacity		W	7300
Cooling Power Input		W	2030
Heating Power Input		W	1870
Cooling Current Input		A	9
Heating Current Input		A	9.3
Rated Input		W	3500
Rated Cooling Current		A	13
Rated Heating Current		A	14
Air Flow Volume		m <sup>3</sup> /h	1000/850/760/580/520/450/400/280
Dehumidifying Volume		L/h	2.40
EER		W/W	3.51
COP		W/W	3.90
SEER			7
SCOP(Average/WarmerColder)			4.30/5.50/3.40
Application Area		m <sup>2</sup>	27-42
Indoor Unit	Model		1.GWH24AUDXF-K6DNA1A/I 2.GWH24AUDXF-K6DNA2A/I
	Product Code		1.CB437N04700/CB437N04702/CB437N04706/CB437N04704/ CB437N04703/CB437N04710 2.CB597N00300/CB597N00302
	Fan Type		Cross-flow
	Fan Diameter Length(DXL)	mm	Φ106×739
	Cooling Speed	r/min	1400/1200/1120/1050/980/860/750/550
	Heating Speed	r/min	1400/1200/1120/1050/950/850/750
	Fan Motor Power Output	W	45
	Fan Motor RLA	A	0.25
	Fan Motor Capacitor	μF	/
	Heater Power Input	W	/
	Evaporator Form		Aluminum Fin-copper Tube
	Evaporator Pipe Diameter	mm	Φ7
	Evaporator Row-fin Gap	mm	2-1.4
	Evaporator Coil Length (LXDXW)	mm	745×22.8×342.9
	Swing Motor Model		MP24AK/MP24HF/MP24BA
	Swing Motor Power Output	W	1.5/1.5/1.5
	Fuse Current	A	3.15
	Sound Pressure Level	dB (A)	Cooling:48/44/41/40/38/36/33/27 Heating:50/47/43/41/40/36/35
	Sound Power Level	dB (A)	Cooling:65/59/56/55/53/51/48/42 Heating:64/62/58/56/55/51/50
	Dimension (WXHxD)	mm	993×311×222
	Dimension of Carton Box (LXWXH)	mm	1050×377×288
Dimension of Package (LXWXH)	mm	1055×385×298	
Net Weight	kg	13	
Gross Weight	kg	15.5	

Outdoor Unit	Outdoor Unit Model		GWH24AUDXF-K6DNA1A/O(LC)	
	Outdoor Unit Product Code		CB437W04701	
	Compressor Manufacturer		ZHUHAI LANDA COMPRESSOR CO.,LTD	
	Compressor Model		QXFS-M180zX170	
	Compressor Oil		/	
	Compressor Type		Rotary	
	Compressor LRA.	A		24.00
	Compressor RLA	A		3.50
	Compressor Power Input	W		1350
	Compressor Overload Protector			HPC 115/95U1 KSD115°C
	Throttling Method			Electron expansion valve
	Set Temperature Range	°C		16~30
	Cooling Operation Ambient Temperature Range	°C		-15~50
	Heating Operation Ambient Temperature Range	°C		-15~30
	Condenser Form			Aluminum Fin-copper Tube
	Condenser Pipe Diameter	mm		Φ7.94
	Condenser Rows-fin Gap	mm		2-1.4
	Condenser Coil Length (LXDXW)	mm		934×38.1×616
	Fan Motor Speed	rpm		800
	Fan Motor Power Output	W		60
	Fan Motor RLA	A		0.65
	Fan Motor Capacitor	μF		/
	Outdoor Unit Air Flow Volume	m <sup>3</sup> /h		3600
	Fan Type			Axial-flow
	Fan Diameter	mm		Φ520
	Defrosting Method			Automatic Defrosting
	Climate Type			T1
	Isolation			I
	Moisture Protection			IPX4
	Permissible Excessive Operating Pressure for the Discharge Side	MPa		4.3
	Permissible Excessive Operating Pressure for the Suction Side	MPa		2.5
	Sound Pressure Level	dB (A)		59
	Sound Power Level	dB (A)		70
Dimension(WXHxD)	mm		958×660×402	
Dimension of Carton Box (LXWXH)	mm		1029×453×715	
Dimension of Package(LXWXH)	mm		1032×456×737	
Net Weight	kg		45	
Gross Weight	kg		49.5	
Refrigerant			R32	
Refrigerant Charge	kg		1.4	
Connection Pipe	Connection Pipe Length	m	5	
	Connection Pipe Gas Additional Charge	g/m	40	
	Outer Diameter Liquid Pipe		1/4"	
	Outer Diameter Gas Pipe		5/8"	
	Max Distance Height	m	10	
	Max Distance Length	m	25	
Note: The connection pipe applies metric diameter.				

The above data is subject to change without notice. Please refer to the nameplate of the unit.

## 2.2 Capacity Variation Ratio According to Temperature

Heating operation ambient temperature range is -25°C~30°C

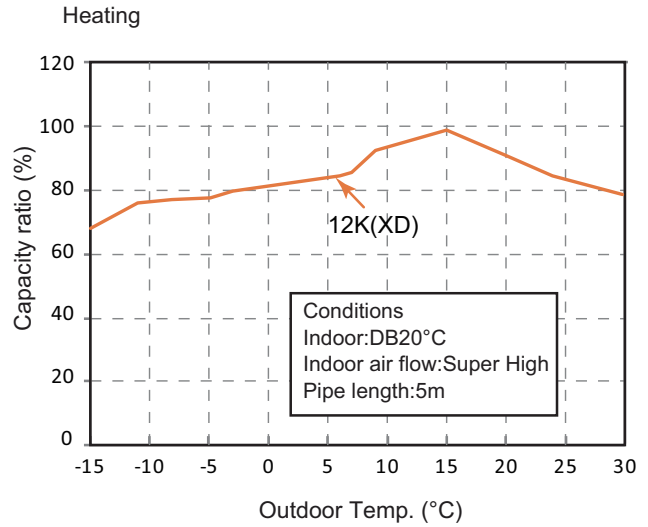
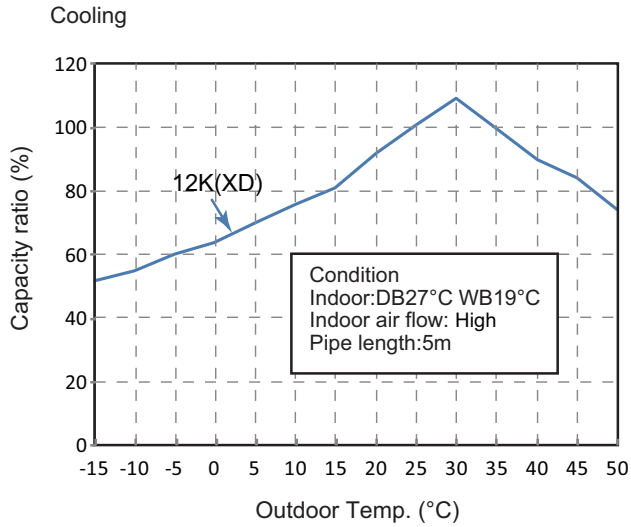
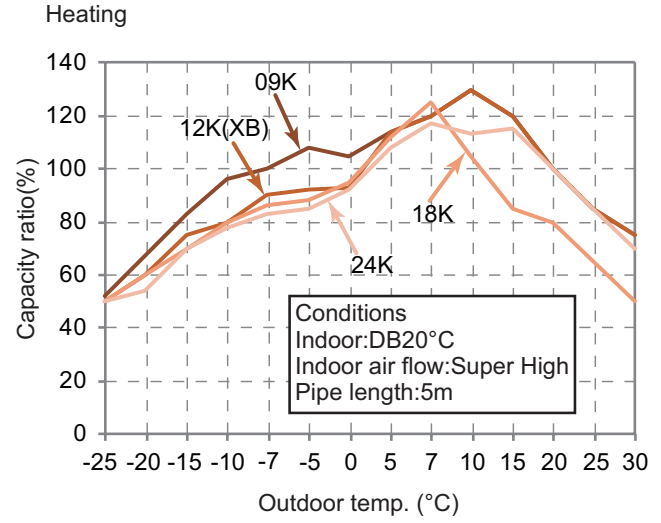
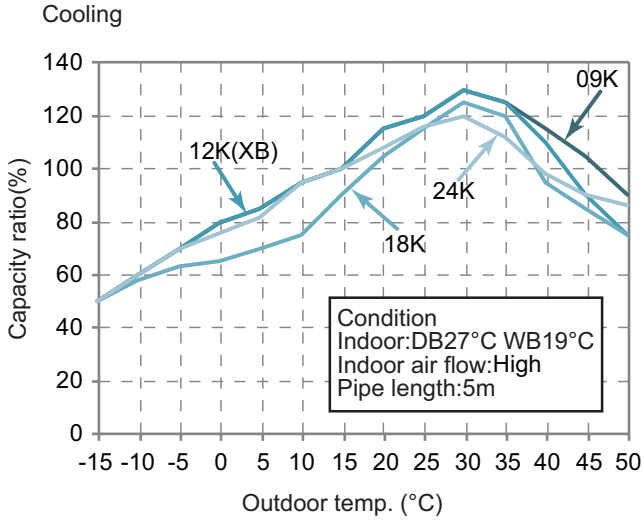

Heating operation ambient temperature range is -15°C~30°C

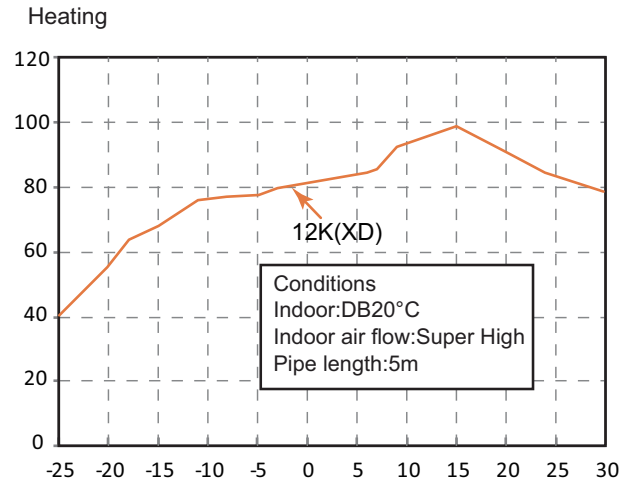
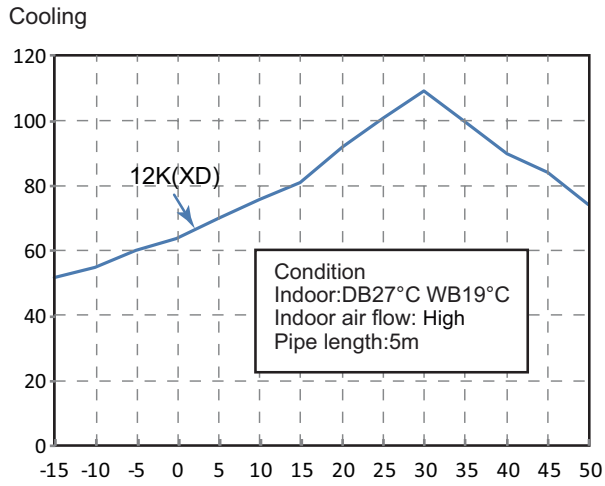
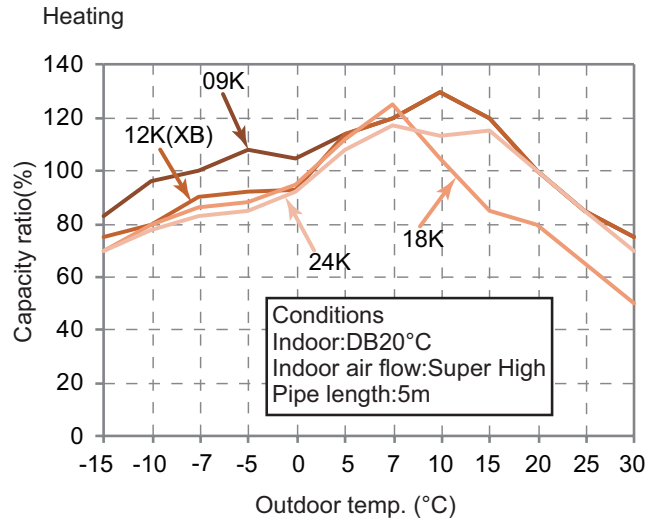
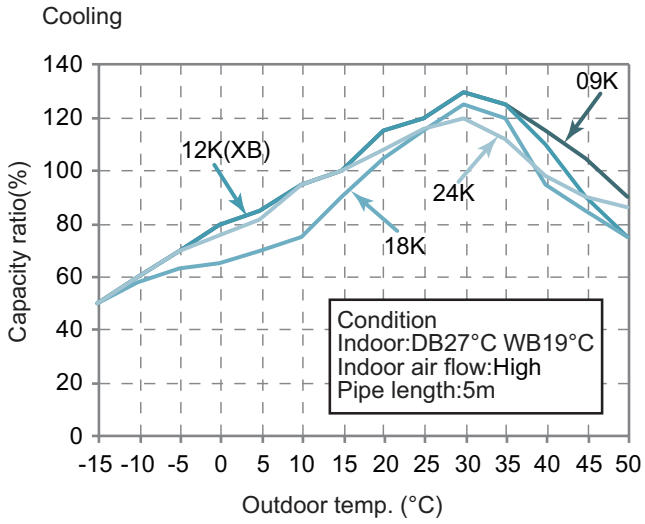

## 2.3 Cooling and Heating Data Sheet in Rated Frequency

Cooling:

Rated cooling condition(°C) (DB/WB)		Model	Pressure of gas pipe connecting indoor and outdoor unit	Inlet and outlet pipe temperature of heat exchanger		Fan speed of indoor unit	Fan speed of outdoor unit
Indoor	Outdoor			P (MPa)	T1 (°C)		
27/19	35/24	09K	0.8~1.1	12 ~ 15	65 ~ 38	Super High	High
27/19	35/24	12K	0.9~1.1	12 ~ 14	75 ~ 37	Super High	High
27/19	35/24	18K	0.9~1.1	12 ~ 14	75 ~ 37	Super High	High
27/19	35/24	24K	0.9~1.1	12 ~ 14	75 ~ 37	Super High	High

Heating:

Rated heating condition(°C) (DB/WB)		Model	Pressure of gas pipe connecting indoor and outdoor unit	Inlet and outlet pipe temperature of heat exchanger		Fan speed of indoor unit	Fan speed of outdoor unit
Indoor	Outdoor			P (MPa)	T1 (°C)		
20/-	7/6	09K	2.8~3.2	63 ~ 35	2 ~ 5	Super High	High
20/-	7/6	12K	2.2~2.4	70 ~ 35	2 ~ 4	Super High	High
20/-	7/6	18K	2.2~2.4	70 ~ 40	1 ~ 5	Super High	High
20/-	7/6	24K	2.2~2.4	70 ~ 35	2 ~ 4	Super High	High

**Instruction:**

T1: Inlet and outlet pipe temperature of evaporator

T2: Inlet and outlet pipe temperature of condenser

P: Pressure at the side of big valve

Connection pipe length: 5 m.

# 3. Outline Dimension Diagram

## 3.1 Indoor Unit

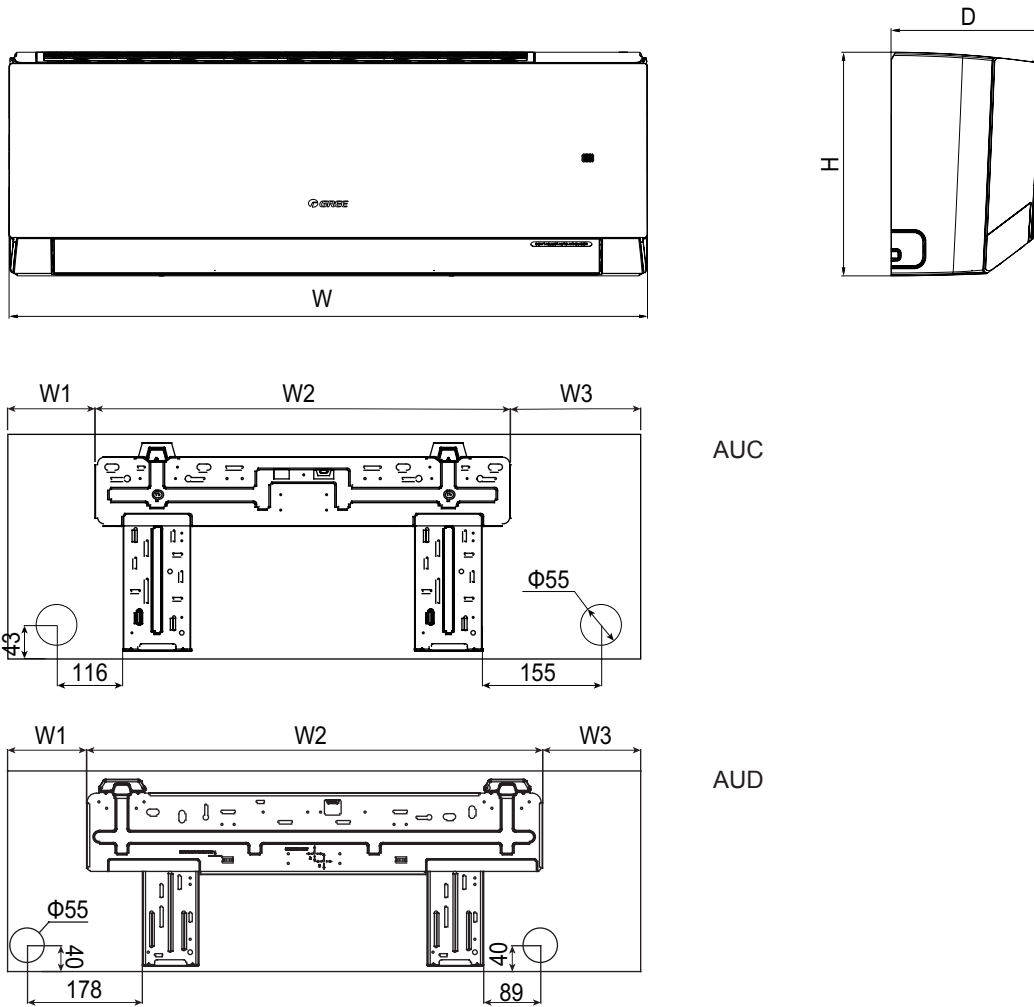

Model (-The first three characters)	W	H	D	W1	W2	W3
AUC	837	293	200	119	542	176
AUD	993	311	222	128	707.5	157.5

### 3.2 Outdoor Unit

GWH09AUCXB-K6DNA1A/O GWH12AUCXB-K6DNA1A/O

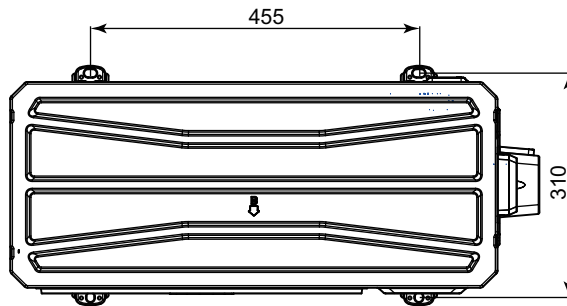
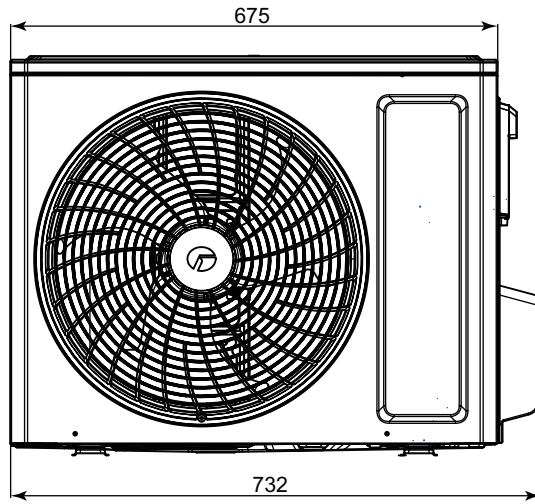
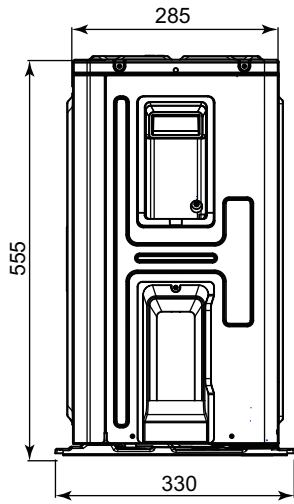

Unit:mm

GWH18AUDXD-K6DNA1A/O GWH12AUCXD-K6DNA1C/O  
(The front grill appearance is for reference only)

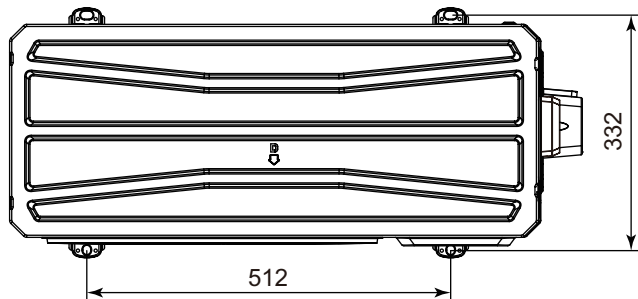
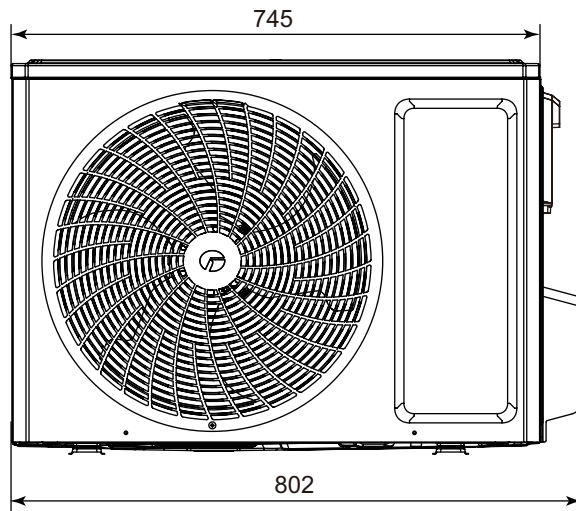
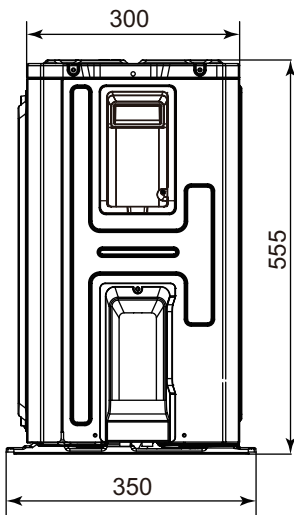

Unit:mm



GWH24AFE-K6DNA2I/O

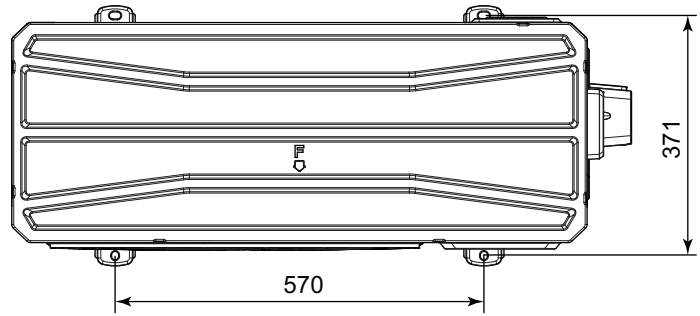
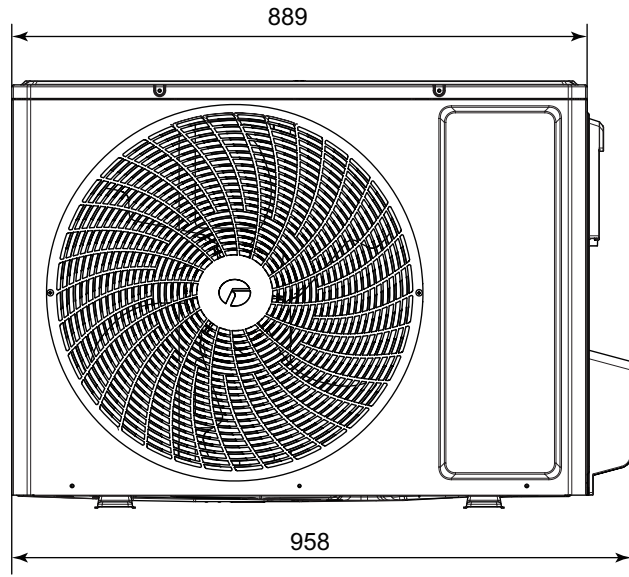
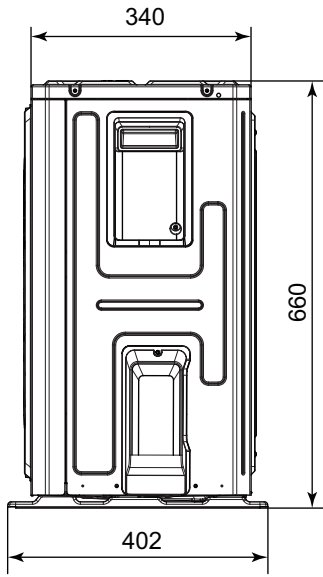

Unit:mm

# 4. Refrigerant System Diagram

09K

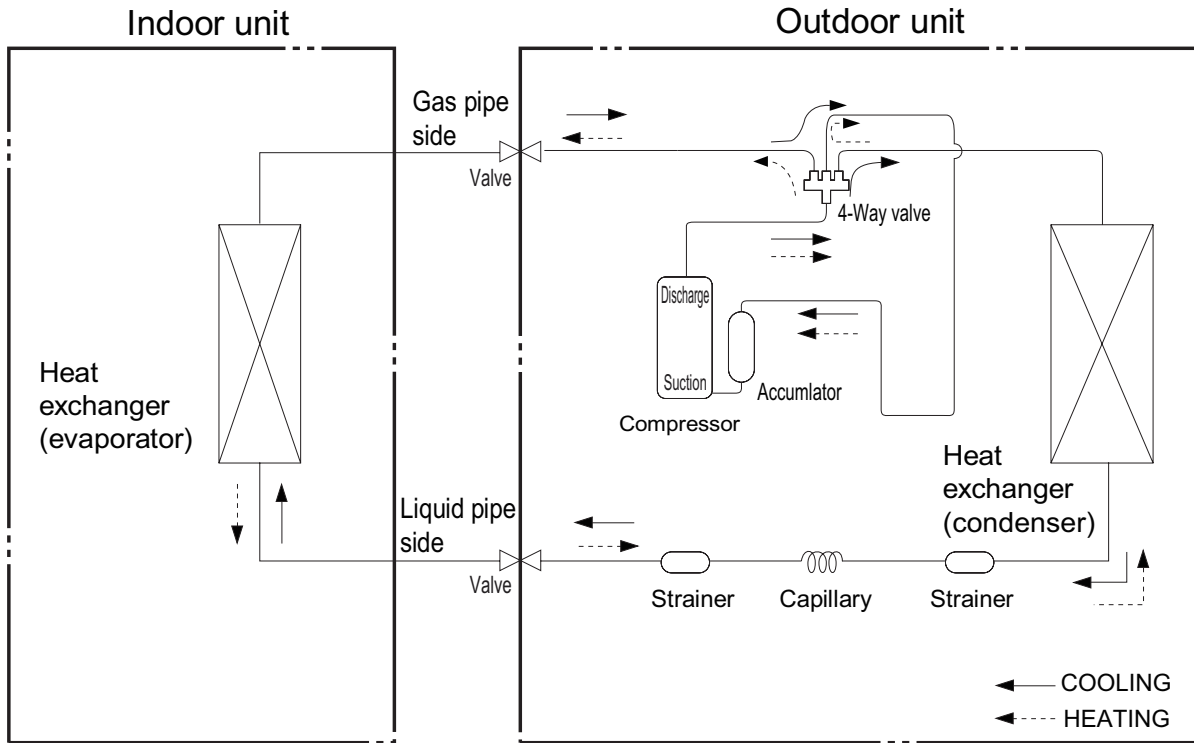

Connection pipe specification:  
 Liquid pipe: 1/4"  
 Gas pipe: 3/8"

12/18/24K

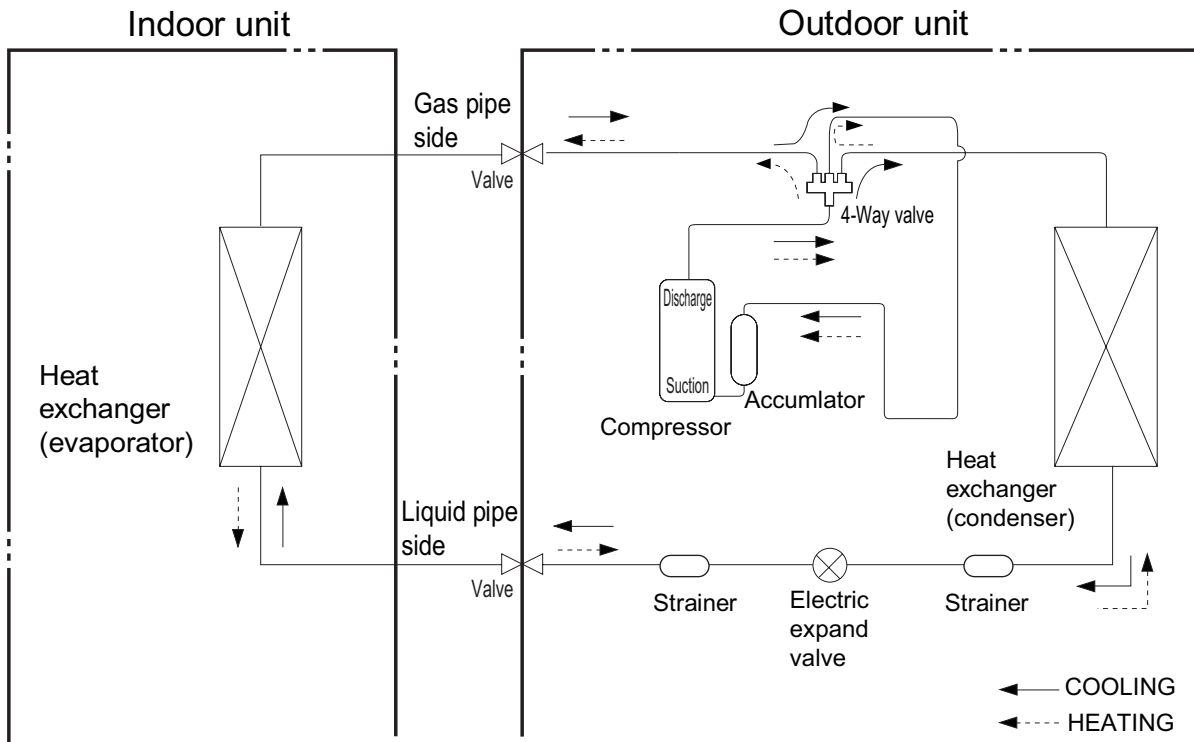

Connection pipe specification:  
 Liquid pipe: 1/4"  
 Gas pipe: 3/8" (09/12K(XB))  
 Gas pipe: 1/2" (12K(XD)/18K)  
 Gas pipe: 5/8" (24K)

# 5. Electrical Part

## 5.1 Wiring Diagram

### • Instruction

Symbol	Symbol Color	Symbol	Symbol Color	Symbol	Name
WH	White	GN	Green	CAP	Jumper cap
YE	Yellow	BN	Brown	COMP	Compressor
RD	Red	BU	Blue	⊕	Grounding wire
YEGN	Yellow/Green	BK	Black	/	/
VT	Violet	OG	Orange	/	/

Note: Jumper cap is used to determine fan speed and the swing angle of horizontal lover for this model.

### • Indoor Unit

09K/12K(XB)

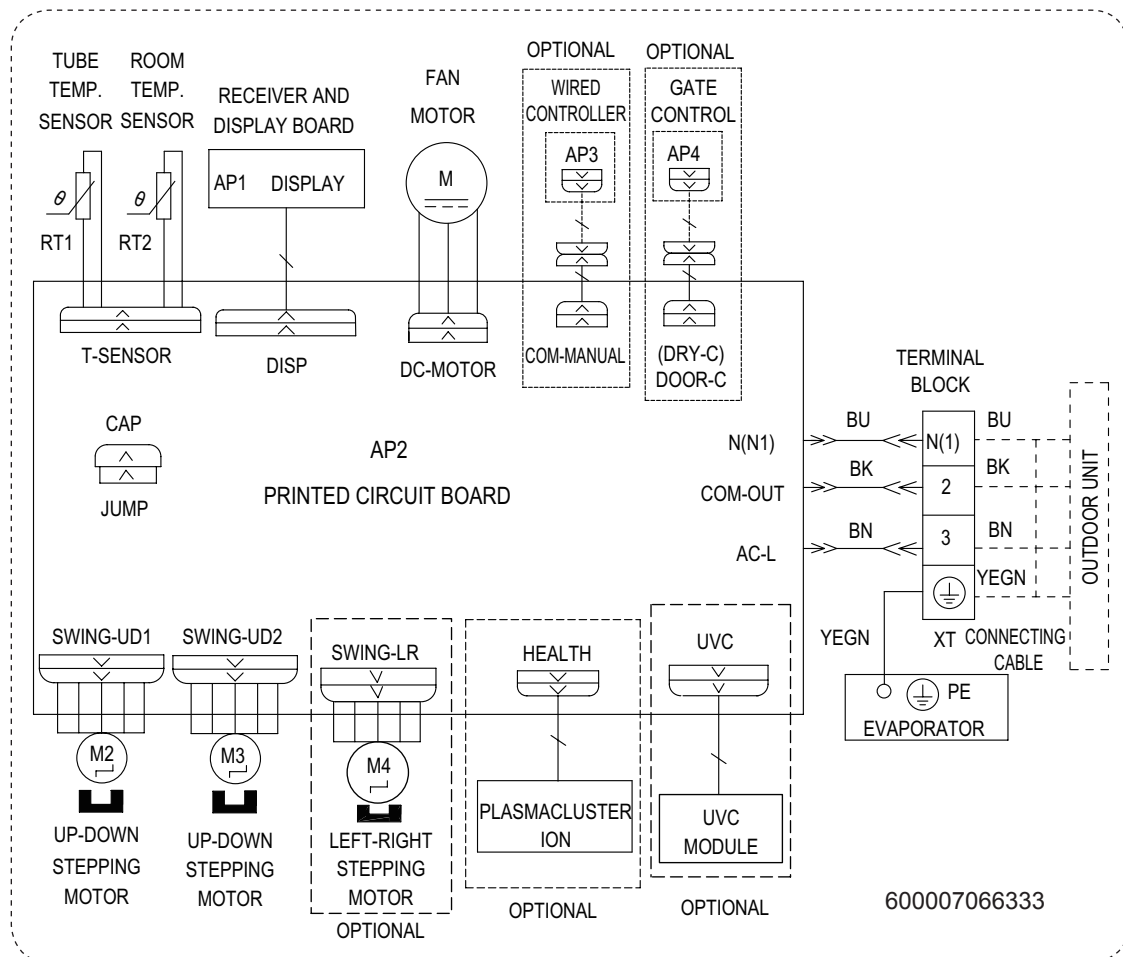

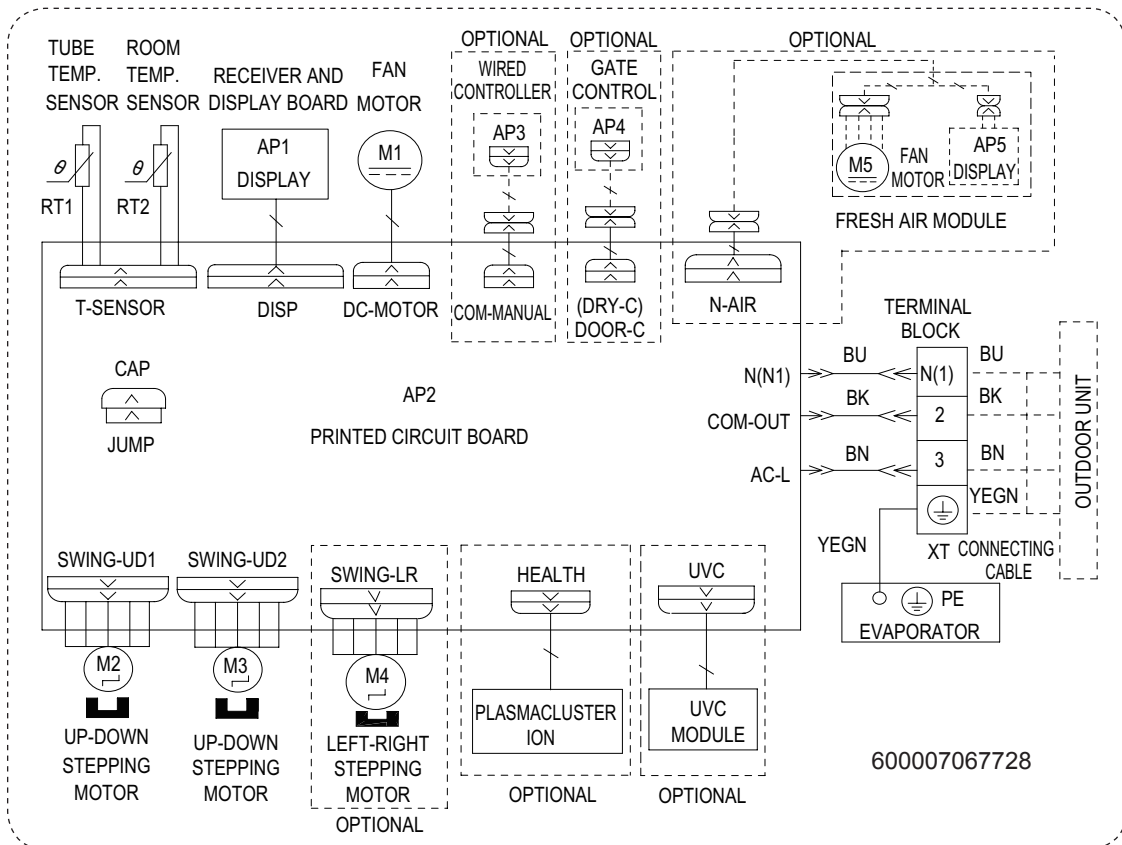
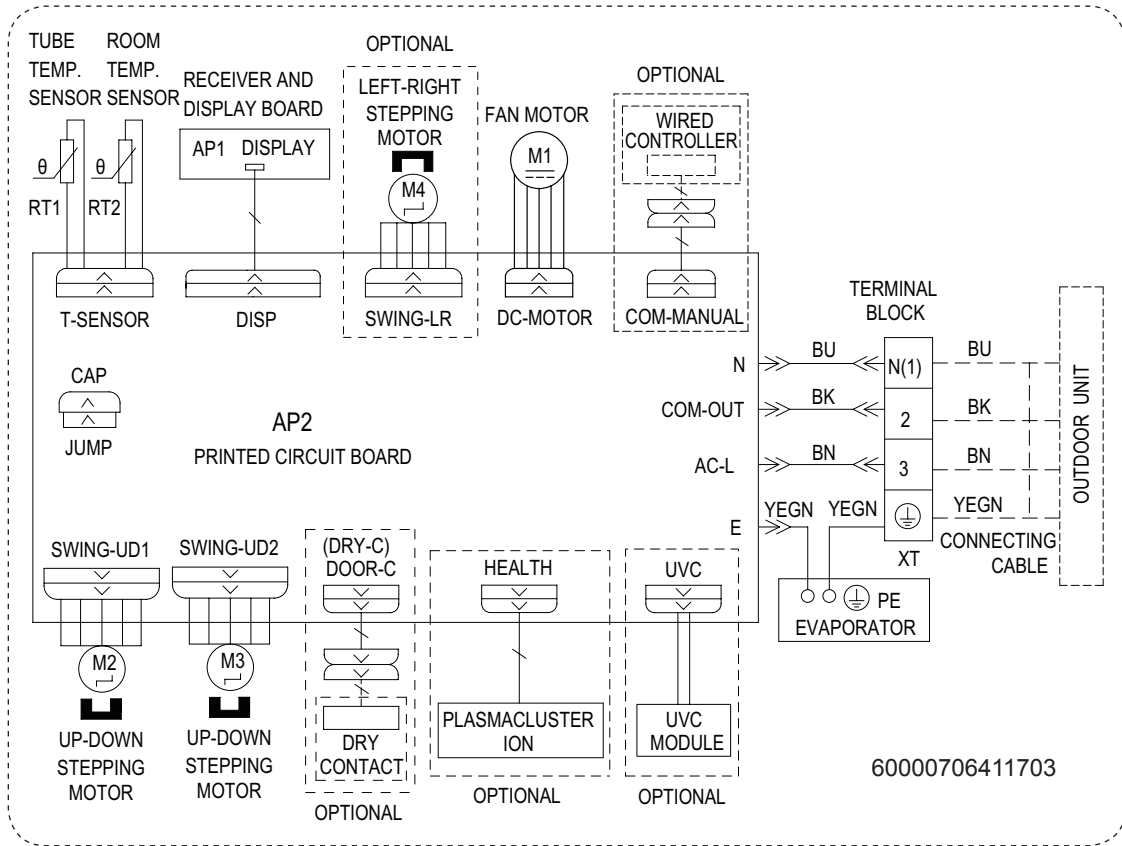



## 5.2 PCB Printed Diagram

### Indoor Unit

GWH09AUCXB-K6DNA1A/I  
GWH09AUCXB-K6DNA2A/I

GWH12AUCXB-K6DNA1A/I  
GWH12AUCXB-K6DNA2A/I

GWH18AUDXD-K6DNA1A/I  
GWH18AUDXD-K6DNA2A/I

GWH24AUDXF-K6DNA1A/I  
GWH24AUDXF-K6DNA2A/I

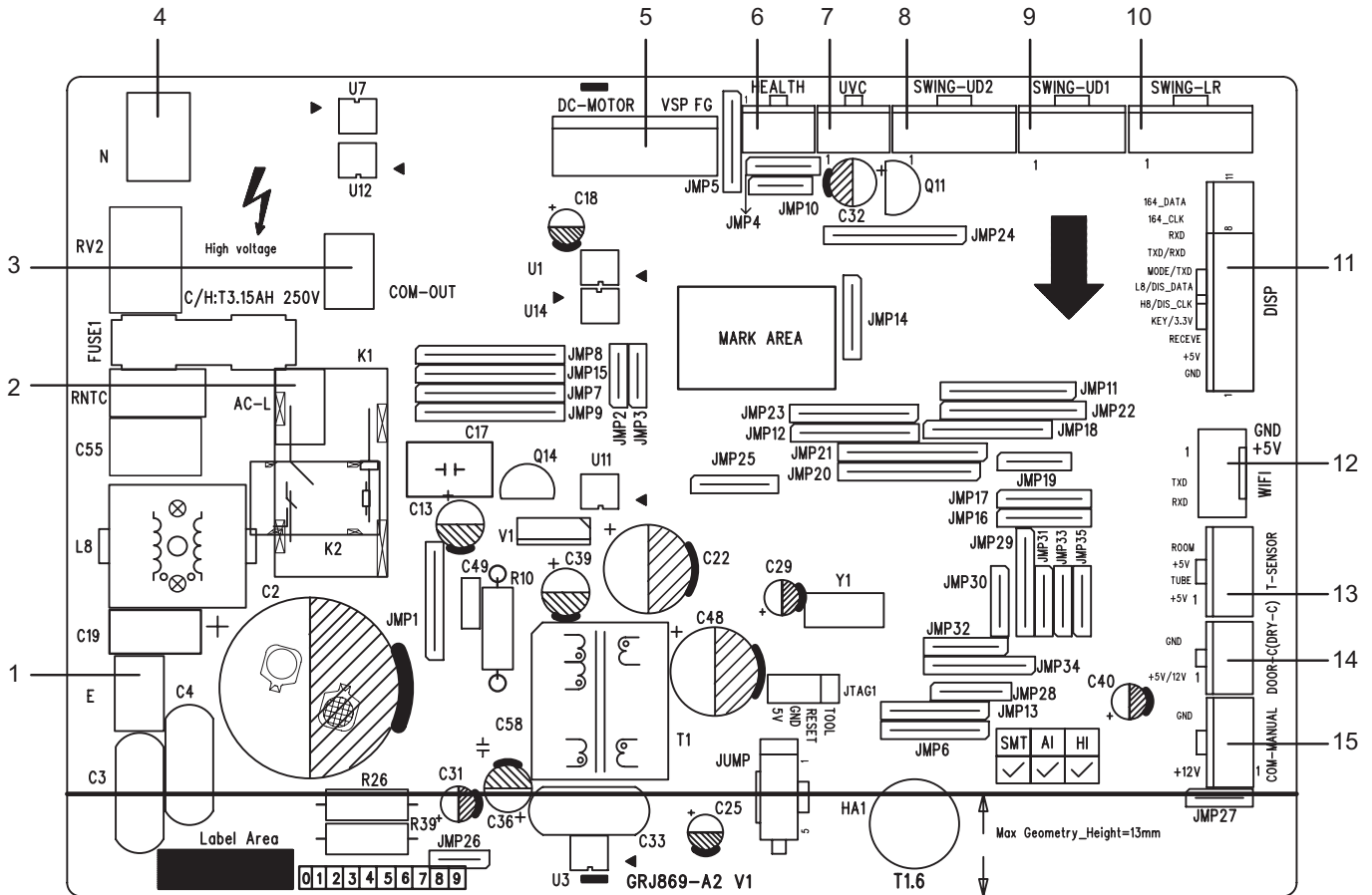

No.	Name
1	Earthing wire
2	Live wire
3	Communication interface
4	Neutral wire
5	DC fan
6	Cold plasma
7	Ultraviolet clean
8	Up&down swing 2

No.	Name
9	Up&down swing 1
10	Left&right swing
11	Interface of display board
12	Interface of WIFI
13	Temperature sensor
14	Door control
15	Wired controller

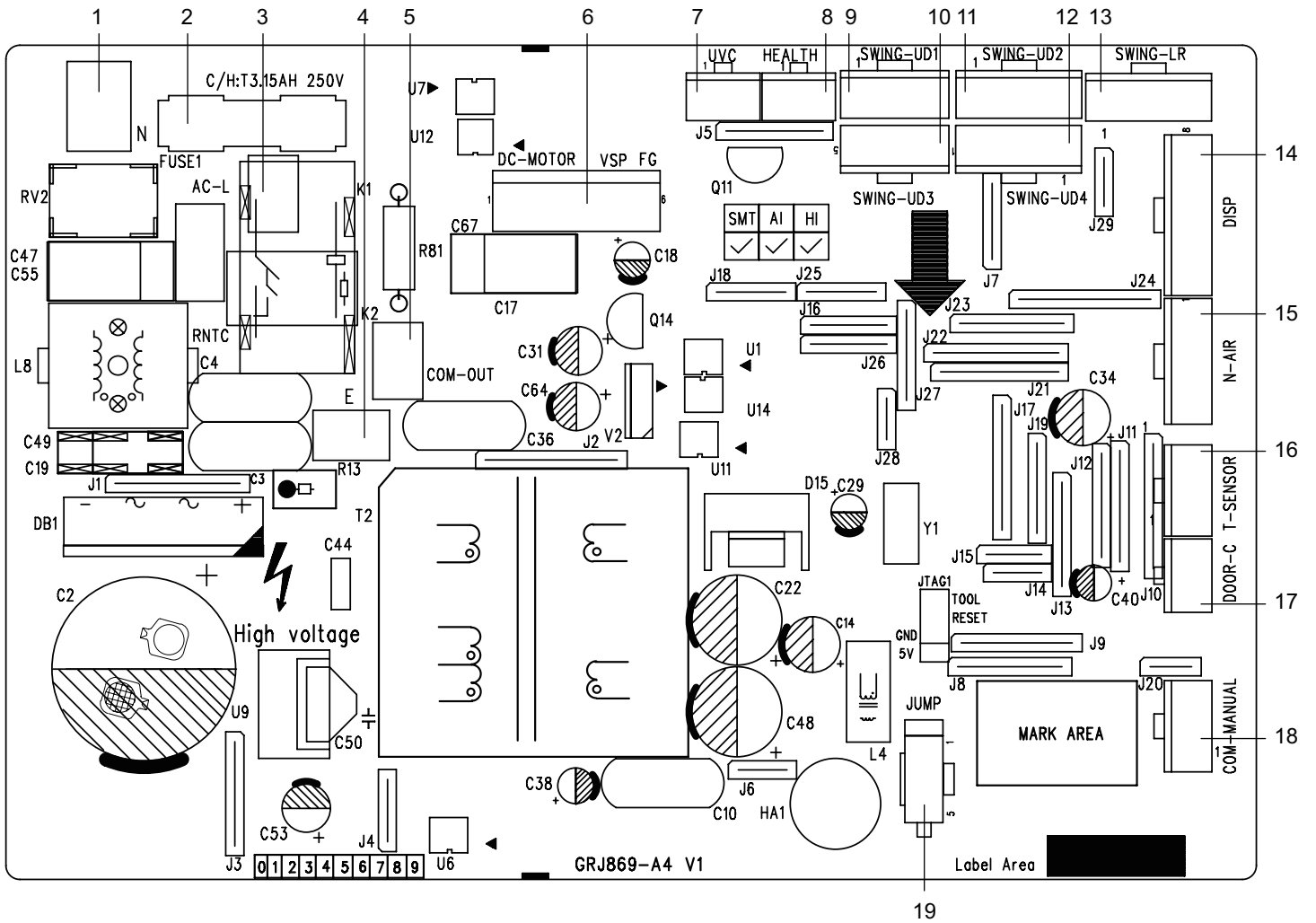

No.	Name
1	Neutral Wire Insertion
2	Fuse
3	Live Wire Insertion
4	Earthing Wire Insertion
5	Communication Wire Insertion
6	Brushless DC Motor Needle Stand
7	Ultraviolet cleaning Needle Stand
8	Health Function Needle Stand
9	Up & Down Swing Needle Stand 1
10	Up & Down Swing Needle Stand 3

No.	Name
11	Up & Down Swing Needle Stand 2
12	Up & Down Swing Needle Stand 4
13	Left & Right Swing Needle Stand
14	Display Board Needle Stand
15	Fresh air Function Needle Stand
16	Temperature Sensor Needle Stand
17	Door Control Needle Stand
18	Wired Controller Needle Stand
19	Jumper Needle Stand

# Outdoor Unit

GWH09AUCXB-K6DNA1A/O

GWH12AUCXB-K6DNA1A/O

GWH12AUCXD-K6DNA1C/O

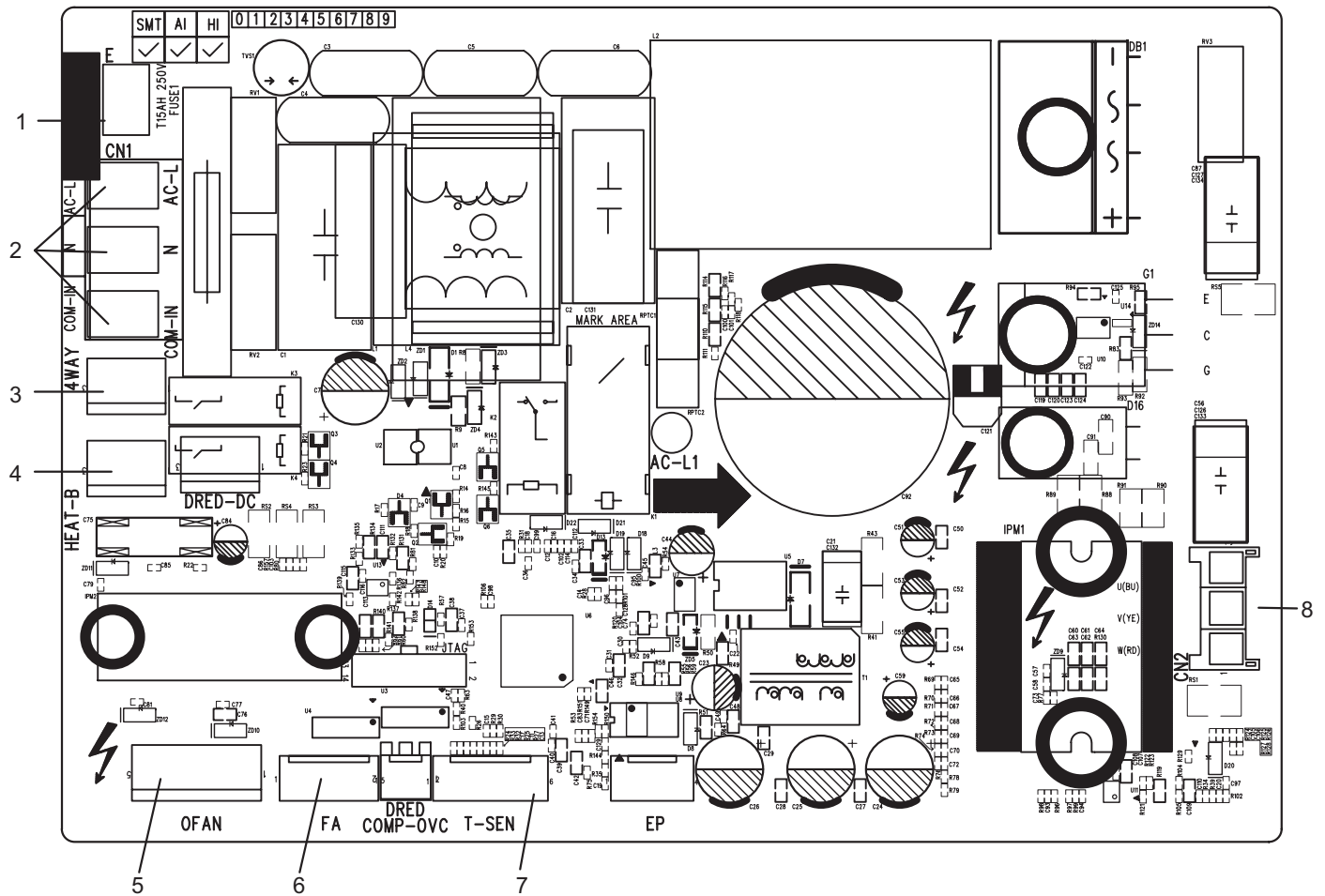

No.	Name
1	Earthing wire
2	Neutral wire, live wire and communication cable
3	4-way valve
4	Electric heating belt of chassis
5	Outdoor fan
6	Electronic expansion valve
7	Temperature sensor
8	Three-phase terminal of compressor



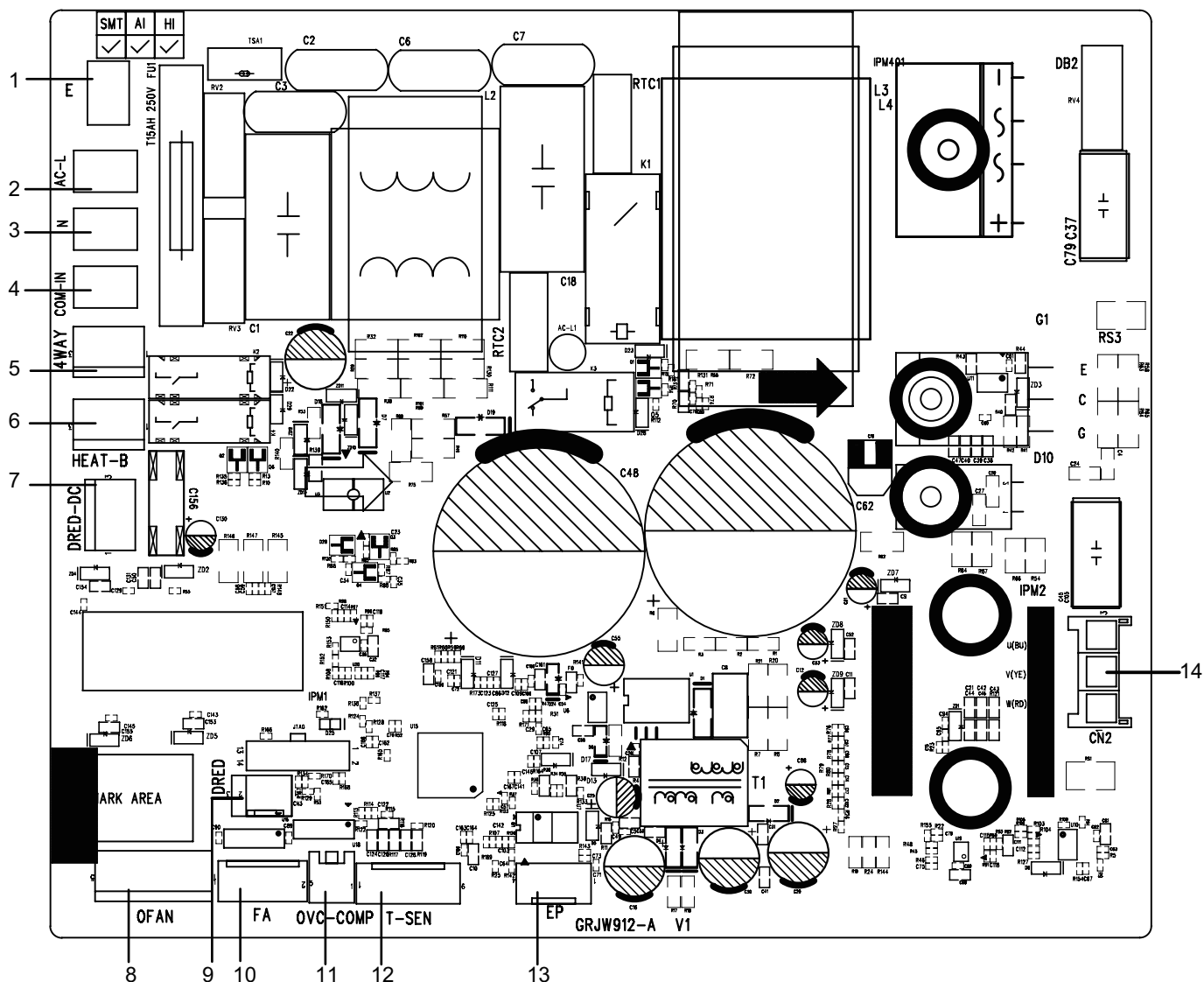

No.	Name
1	Earthing wire
2	Live wire
3	Neutral wire
4	communication cable
5	4-way valve
6	Electric heating belt of chassis
7	DRED-DC(preliminary)

No.	Name
8	Outdoor fan
9	DRED(preliminary)
10	Electronic expansion valve
11	Overload
12	Temperature sensor
13	EE flash drive
14	Three-phase terminal of compressor

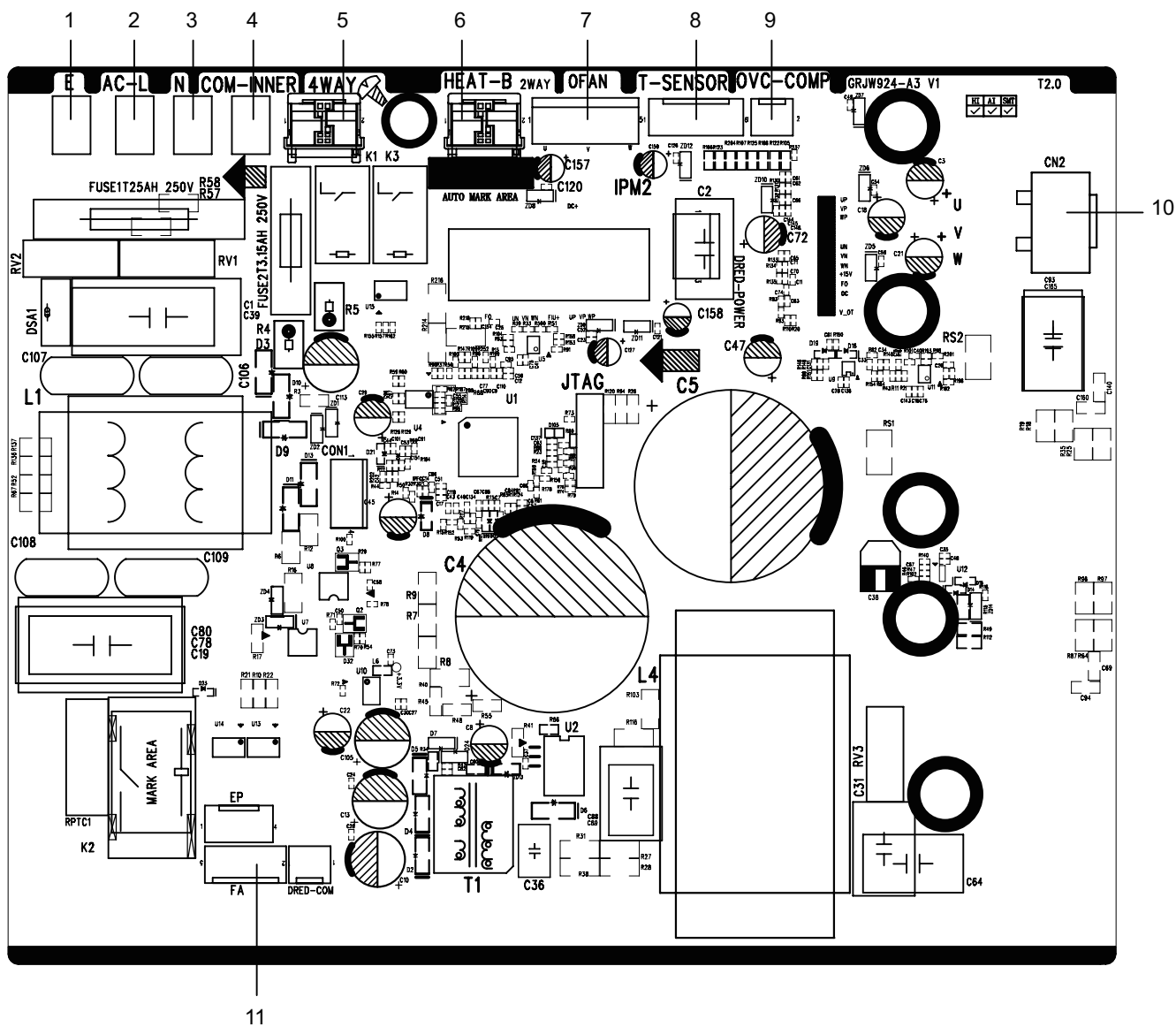

No.	Name	No.	Name
1	Earthing wire	7	Outdoor fan
2	Live wire	8	Temperature sensor
3	Neutral wire	9	Overload
4	communication cable	10	Three-phase terminal of compressor
5	4-way valve	11	Electronic expansion valve
6	Electric heating belt of chassis		

# 6. Function and Control

## 6.1 Remote Controller Introduction for YAA1FB18(WiFi)

### Introduction for icons on display screen



### Introduction for buttons on remote controller

#### NOTE:

- This is a general use remote controller. It could be used for the air conditioner with multifunction. For the functions which the model doesn't have, if press the corresponding button on the remote controller, the unit will keep the original running status.
- After putting through the power, the air conditioner will give out a sound. Power indicator "⏻" is ON. After that, you can operate the air conditioner by using remote controller.
- Under on status, pressing the button on the remote controller, the signal icon "📶" on the display of remote controller will blink once and the air conditioner will give out a "di" sound, which means the signal has been sent to the air conditioner.

**ON/OFF** button

Press this button to turn on the unit. Press this button again to turn off the unit.

**MODE** button

Press this button to select your required operation mode.

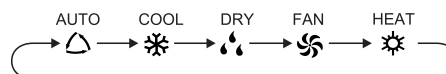

- When selecting auto mode, air conditioner will operate automatically according to the sensed temperature. Press "FAN" button can adjust fan speed. Press "🌀" / "🌀" button can adjust fan blowing angle.
- After selecting cool mode, air conditioner will operate under cool mode. Press " + " or " - " button to adjust set temperature. Press "FAN" button to adjust fan speed. Press "🌀" / "🌀" button to adjust fan blowing angle.
- When selecting dry mode, the air conditioner operates at low speed under dry mode. Under dry mode, fan speed can't be adjusted. Press "🌀" / "🌀" button to adjust fan blowing angle.
- When selecting fan mode, the air conditioner will only blow fan, no cooling and no heating. Press "FAN" button to adjust fan speed. Press "🌀" / "🌀" button to adjust fan blowing angle.
- When selecting heat mode, the air conditioner operates under heat mode. Press " + " or " - " button to adjust set temperature. Press "FAN" button to adjust fan speed. Press "🌀" / "🌀" button to adjust fan blowing angle.

#### NOTE:

- For preventing cold air, after starting up heat mode, indoor unit will delay 1~5 minutes to blow air (Actual delay time depends on indoor ambient temperature).
- Set temperature range from remote controller: 16~30°C(61-86°F).
- This mode indicator is not available for some models.
- Cooling only unit won't receive heat mode signal. If setting heat mode with remote controller, press " ON/OFF " button can't start up the unit.

### Introduction for icons on display screen

	Quiet	
	Set fan speed	
	Turbo mode	
	Send signal	
Operation mode		Auto mode
		Cool mode
		Dry mode
		Fan mode
		Heat mode
	X-FAN function	
	Humidity control	
	Power limiting operation	
	Set temperature	
	Indoor ambient temp.	
	Indoor ambient humidity	
	TIMER ON / TIMER OFF	
	Left & right swing	
	Up & down swing	
	Child lock	
	Fast cool	
	Health and UVC functions	
	WiFi function	
	LED	
	Auto LED	
	I feel	
	Sleep mode	



### **FAST COOL** button

Press this button under cooling mode can select 25°C(77°F) fast cooling mode, 16°C(61°F) fast cooling mode and normal cooling mode circularly. " " icon will be displayed on the remote controller under fast cooling mode.

Once it enters into fast cooling mode, the fan speed is auto fan and the set temperature is 25°C(77°F) or 16°C(61°F). At this time, the set temperature flashes to display for 5s. In the flashing period, press "+" or "-" button to adjust the set temperature.

Press "FAN" button to adjust the fan speed. If the set temperature and the fan speed haven't been adjusted during that time, the remote controller and the indoor unit will operate under current set temperature and fan speed for 20 minutes. 20 minutes later, the set temperature and the fan speed for the remote controller and the indoor unit will turn to the status before quick cooling.

#### **NOTE:**

- If the set temperature and the fan speed have been adjusted during the operation under fast cooling mode, the unit will exit from the fast cooling mode. Then the indoor unit operates continuously under the adjusted status.
- Fast cooling function is only applicable for some models. If this function is unavailable for this indoor unit, 20 minutes later, the remote controller will turn back to the status before fast cooling. Indoor unit operates continuously according to current status. At this time, status of indoor unit and the display status on the remote controller may be different.
- This function is only available for some models.

### **I FEEL** button

Press this button to start I FEEL function and " " will be displayed on the remote controller. After this function is set, the remote controller will send the detected ambient temperature to the controller and the unit will automatically adjust the indoor temperature according to the detected temperature. Press this button again to turn off I FEEL function and " " will disappear.

- Please put the remote controller near user when this function is set. Do not put the remote controller near the object of high temperature or low temperature in order to avoid detecting inaccurate ambient temperature. When I FEEL function is turned on, the remote controller should be put within the area where indoor unit can receive the signal sent by the remote controller.

### **AUTO CLEAN** button

Under unit off status, press this button to turn on or turn off the auto clean function. When the auto clean function is turned on, indoor unit displays "CL".

During the auto clean process of evaporator, the unit will perform fast cooling or fast heating. There may be some noise, which is the sound of flowing liquid or thermal expansion or cold shrinkage. The air conditioner may blow cool or warm air, which is a normal phenomenon. During cleaning process, please make sure the room is well ventilated to avoid affecting the comfort.

#### **NOTE:**

- The auto clean function can only work under normal ambient temperature. If the room is dusty, clean it once a month; if not,

clean it once every three months. After the auto clean function is turned on, you can leave the room. When auto clean is finished, the air conditioner will enter standby status.

- This function is only available for some models.

### **HEALTH** button

Press this button to turn on or turn off the health and UVC functions in operation status.

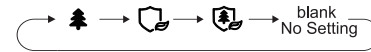

- When selecting " " with remote controller, Cold Plasma will be turn on.
- When selecting " " with remote controller, UVC sterilization function will be turn on.
- When selecting " " with remote controller, Cold Plasma and UVC sterilization function will be turn on together.

#### **NOTE:**

- Health and UVC sterilization are only available for some models.

### **TEMP HUM.** button

By pressing this button, you can see indoor ambient temperature or indoor ambient humidity on indoor unit's display. The setting on remote controller is selected circularly as below:



- When selecting " " with remote controller, temperature indicator on indoor unit displays indoor ambient temperature.
- When selecting " " with remote controller, temperature indicator on indoor unit displays indoor ambient humidity.

### **TIMER** button

- At ON status, press this button once can set TIMER OFF. The character of HOUR and OFF will flash. Press "+" or "-" button within 5s can adjust the time of TIMER ON. After each pressing of "+" or "-" button, time will increase or decrease half an hour. When holding "+" or "-" button, 2s later, the time will change quickly until to reach to your required time. After that, press "TIMER" button to confirm it. The character of HOUR and OFF won't flash again. Cancel TIMER OFF: Press "TIMER" button again under TIMER OFF status.

- At OFF status, press this button once can set TIMER ON. Please refer to TIMER off for detailed operation. Cancel TIMER ON: Press "TIMER" button again under TIMER ON status.

#### **NOTE:**

- Time setting range: 0.5-24 hours.
- Time interval between two operations can't exceed 5s. Otherwise, remote controller will exit the setting status automatically.

### **LIGHT** button

Press this button to control the LED status on the display, the circulation change is as follow:

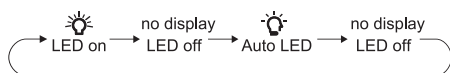

When selecting "☀" (Auto LED) with remote controller, LED indicator on indoor unit will adjust the luminance automatically according to the ambient intensity of illumination.

#### **SLEEP** button

Press this button, can select Sleep 1 (☾), Sleep 2 (☾), Sleep 3 (☾) and cancel the Sleep, circulate between these, after electrified, Sleep Cancel is defaulted.

- Sleep 1 is Sleep mode 1, in Cool modes; sleep status after run for one hour, the main unit setting temperature will increase 1, two hours, setting temperature increased 2, then the unit will run at this setting temperature; In Heat mode: sleep status after run for one hour, the setting temperature will decrease 1, two hours, setting temperature will decrease 2, then the unit will run at this setting temperature.

- Sleep 2 is sleep mode 2, that is air conditioner will run according to the presetting a group of sleep temperature curve.

- Sleep 3 the sleep curve setting under Sleep mode by DIY;

(1) Under Sleep 3 mode, press "AUTO CLEAN" button for a long time, remote controller enters into user individuation sleep setting status, at this time, the time of remote controller will display "1hour", the setting temperature "88" will display the corresponding temperature of last setting sleep curve and blink (The first entering will display according to the initial curve setting value of original factory);

(2) Adjust "+" and "-" button, could change the corresponding setting temperature, after adjusted, press "Turbo" button for confirmation;

(3) At this time, 1hour will be automatically increased at the timer position on the remote control, (that are "2hours" or "3hours" or "8hours"), the place of setting temperature "88" will display the corresponding temperature of last setting sleep curve and blink;

(4) Repeat the above step (2)~(3) operation, until 8 hours temperature setting finished, sleep,curvesetting finished, at this time, the remote controller will resume the original timer display; temperature display will resume to original setting temperature.

- Sleep 3 the sleep curve setting under Sleep mode by DIY could be inquired:

The user could accord to sleep curve setting method to inquire the presetting sleep curve, enter into user individuation sleep setting status, but do not change the temperature, press "AUTO CLEAN" button directly for confirmation. Note: In the above presetting or enquiry procedure, if continuously within 10s, there is no button pressed, the sleep curve setting within 10s, there is no button pressed, the sleep curve setting status will be automatically quit and resume to display the original displaying. In the presetting or enquiry procedure, press "ON/OFF" button, "MODE" button, "TIMER" button or "SLEEP" button, the sleep curve setting or enquiry status will quit similarly.

#### **WiFi** button

Press "WiFi" button to turn on WiFi function, "WiFi" icon will be displayed on the remote controller;

Hold "WiFi" button for 5s to turn off WiFi function and "WiFi" icon will disappear.

Under off status, press "MODE" and "WiFi" buttons simultaneously for 1s, WiFi module will restore factory settings.

#### **NOTE:**

- This function is only available for some models.

### Function introduction for combination buttons

#### Energy-saving function

Under cooling mode, press "TEMP/HUM." and "TIMER" buttons simultaneously to start up or turn off energy-saving function. When energy-saving function is started up, "SE" will be shown on remote controller, and air conditioner will adjust the set temperature automatically according to ex-factory setting to reach to the best energy-saving effect. Press "TEMP/HUM." and "TIMER" buttons simultaneously again to exit energy-saving function.

#### **NOTE:**

- Under energy-saving function, fan speed is defaulted at auto speed and it can't be adjusted.

- Under energy-saving function, set temperature can't be adjusted.

- Sleep function and energy-saving function can't operate at the same time. If energy-saving function has been set under cool mode, press "SLEEP" button will cancel energy-saving function. If sleep function has been set under cool mode, start up the energy-saving function will cancel sleep function.

#### Child lock function

Press "+" and "-" simultaneously to turn on or turn off child lock function. When child lock function is on, "🔒" icon is displayed on remote controller. If you operate the remote controller, the "🔒" icon will blink three times without sending signal to the unit.

#### Temperature display switchover function

Under OFF status, press "-" and "MODE" buttons simultaneously to switch temperature display between °C and °F.

#### Volume control of IDU Buzzer

Press "LIGHT" and "MODE" buttons simultaneously to reduce the sound level of the indoor unit' buzzer.

#### **NOTE:**

- This function is only available for some models.

#### Clean reminder function of filter

The reminder function is defaulted to be OFF. Hold TEMP/HUM. button on the remote controller for 5s to turn it on. The buzzer will give out sound for 0.5s and the dual-8 nixie tube on the display will be on for 3s;

Once the reminder function is turned on, when the air conditioner has reached to the set time, the dual-8 nixie tube will flash about 30s when the unit is turned on each time to remind the user to clean the filter; you can turn off this cycle reminder by holding the TEMP/HUM. button on the remote controller for 5s and then the air conditioner will count time again.

#### **NOTE:**

- Once the reminder function is turned on, only this cycle reminder can be cleared.

- This function is only available for some models.

## function

 function is for limiting power of the whole unit.

Press "SLEEP" and "MODE" buttons simultaneously, the remote controller will circularly display as the following:

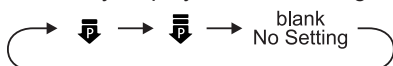



- Maximum power limited under the mode is lower than that of mode.
- If you want to cancel the power limiting function, press the button till the icon in remote controller is not displayed.
- When the remote controller is turned off, power limiting function is cancelled. If you want to activate the function, please repress this button.
- If the current power is lower than the maximum power of mode, then the power will not be limited after entering into such mode.
- For the model with one outdoor unit and two indoor units, if any one of indoor units enters into power limiting function, the outdoor unit will enter into the set limiting power mode of indoor unit; when two indoor units enter into power limiting mode, then the power of outdoor unit will be limited according to the lower power of the two indoor units.

### NOTE:

- This button is only available for the model with such function.

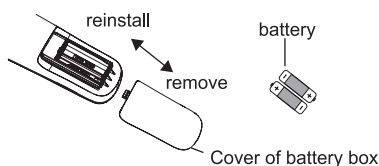
## Replacement of batteries in remote controller



1. Press the back side of remote controller marked with "", as shown in the fig, and then push out the cover of battery box along the arrow direction.
2. Replace two 7# (AAA 1.5V) dry batteries, and make sure the position of "+" polar and "-" polar are correct.
3. Reinstall the cover of battery box.

### NOTICE:

- During operation, point the remote control signal sender at the receiving window on indoor unit.
- The distance between signal sender and receiving window should be no more than 8m, and there should be no obstacles between them.
- Signal may be interfered easily in the room where there is fluorescent lamp or wireless telephone; remote controller should be close to indoor unit during operation.
- Replace new batteries of the same model when replacement is required.
- When you don't use remote controller for a long time, please take out the batteries.
- If the display on remote controller is fuzzy or there's no display, please replace batteries.

## 6.2 Remote Controller Introduction for YBE1F/YBE1F1/YBE1FB2

### Introduction for icons on display screen



### Introduction for buttons on remote controller

#### NOTE:

- This is a general use remote controller. It could be used for the air conditioner with multifunction. For the functions which the model doesn't have, if press the corresponding button on the remote controller, the unit will keep the original running status.
- After putting through the power, the air conditioner will give out a sound. Power indicator "⏻" is ON. After that, you can operate the air conditioner by using remote controller.
- Under on status, pressing the button on the remote controller, the signal icon "📶" on the display of remote controller will blink once and the air conditioner will give out a "di" sound, which means the signal has been sent to the air conditioner.

 On/Off button

Press this button to turn on the unit. Press this button again to turn off the unit.

 Mode button

Press this button to select your required operation mode.



- When selecting auto mode, air conditioner will operate automatically according to the sensed temperature. Press "Fan" button can adjust fan speed. Press "🌀" / "🌀" button can adjust fan

blowing angle.

- After selecting cool mode, air conditioner will operate under cool mode. Press " + " or " - " button to adjust set temperature. Press "Fan" button to adjust fan speed. Press "🌀" / "🌀" button to adjust fan blowing angle.

- When selecting dry mode, the air conditioner operates at low speed under dry mode. Under dry mode, fan speed can't be adjusted. Press "🌀" / "🌀" button to adjust fan blowing angle.

- When selecting fan mode, the air conditioner will only blow fan, no cooling and no heating. Press "Fan" button to adjust fan speed. Press "🌀" / "🌀" button to adjust fan blowing angle.

- When selecting heat mode, the air conditioner operates under heat mode. Press " + " or " - " button to adjust set temperature. Press "Fan" button to adjust fan speed. Press "🌀" / "🌀" button to adjust fan blowing angle.

#### NOTE:

























- For preventing cold air, after starting up heat mode, indoor unit will delay 1~5 minutes to blow air (Actual delay time depends on indoor ambient temperature).

- Set temperature range from remote controller: 16~30°C(61~86°F).

- This mode indicator is not available for some models.

- Cooling LED only unit won't receive heat mode signal. If setting heat mode with remote controller, press " ON/OFF " button can't start up the unit.

### Introduction for icons on display screen

	Quiet	
	Set fan speed	
	Turbo mode	
	Send signal	
Operation mode		Auto mode
		Cool mode
		Dry mode
		Fan mode
		Heat mode
	X-FAN function	
	Humidity control	
	Power limiting operation	
	Set temperature	
	Indoor ambient temp.	
	Indoor ambient humidity	
ONOFF	TIMER ON / TIMER OFF	
	Set time	
	Left & right swing	
	Up & down swing	
	Child lock	
	Fast cool	
	Health and UVC functions	
WIFI	WiFi function	
	LED	
	Auto LED	
	I feel	
	Sleep mode	



### Fan button

This button is used for setting Fan Speed in the sequence that goes from AUTO, , , , , , , , to , then back to Auto.

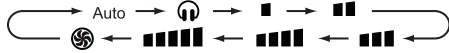

- Low speed
- Low-Medium speed
- Medium speed
- Medium-High speed
- High speed
- Turbo speed
- Quiet speed

#### NOTE:

- It's low fan speed under dry mode.
- X-FAN function Hold fan speed button for 2s in cool or dry mode, the icon " " is displayed and the indoor fan will continue operation for a few minutes in order to dry the indoor unit even though you have turned off the unit. After energization, X-FAN OFF is defaulted. X-FAN is not available in auto, fan or heat mode.
- This function indicates that moisture on evaporator of indoor unit will be blown after the unit is stopped to avoid mould.
- Having set X-FAN function on: After turning off the unit by pressing " On/Off " button indoor fan will continue running for a few minutes. at low speed. In this period, hold fan speed button for 2s to stop indoor fan directly.
- Having set X-FAN function off: After turning off the unit by pressing " On/Off " button, the complete unit will be off directly.

### + / - button

Press " + " or " - " button once increase or decrease set temperature 1°C(°F). Holding " + " or " - " button, 2s later, set temperature on remote controller will change quickly. On releasing button after setting is finished, temperature indicator on indoor unit will change accordingly.

### Wifi button

Press "Wifi" button to turn on WiFi function, "Wifi" icon will be displayed on the remote controller;  
Hold "Wifi" button for 5s to turn off WiFi function and "Wifi" icon will disappear.  
Under off status, press "Mode" and "Wifi" buttons simultaneously for 1s, WiFi module will restore factory settings.

#### NOTE:

- This function is only available for some models.

### Health button

Press this button to turn on or turn off the health function and UVC lamp in operation status.



- When selecting " " with remote controller, Cold Plasma will be turn on.
- When selecting " " with remote controller, UVC lamp will be turn on.
- When selecting " " with remote controller, Cold Plasma and UVC lamp will be turn on together.

#### NOTE:

- Health function and UVC lamp are only available for some models.

### UD-swing button

Press this button can select up & down swing angle. Fan blow angle can be selected circularly as below:

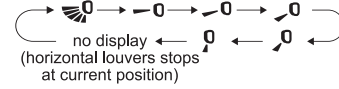

- When selecting " ", air conditioner is blowing fan automatically. Horizontal louver will automatically swing up & down at maximum angle.
- When selecting " , , , , " , a ir conditioner is blowing fan at fixed position. Horizontal louver will stop at the fixed position.
- Hold " " button above 2s to set your required swing angle. When reaching your required angle, release the button.

#### NOTE:

- Press this button continuously more than 2s, the main unit will swing back and forth from up to down, and then loosen the button, the unit will stop swinging and present position of guide louver will be kept immediately.
- Under swing up and down mode, when the status is switched from off to , if press this button again 2s later, status will switch to off status directly; if press this button again within 2s, the change of swing status will also depend on the circulation sequence stated above.

### Humidity button

Under cooling mode, press this button can select humidity control with cooling mode, smart dehumidification with cooling mode, and general cooling mode, and they can be set to operate circularly.

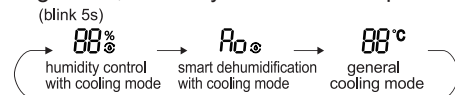

- When humidity control with cooling mode is set, the remote controller will display " " , and humidity value "88" and "%" icon will blink for 5s; you can press "+" and "-" buttons to set the humidity value within 5s.
- Under humidity control with cooling mode, humidity setting range for the remote controller: 40%-80%.  
Temperature can be adjusted under humidity control with cooling mode.
- When smart dehumidification with cooling mode is set, the remote controller will display " " ; the remote controller and indoor unit will display "Ao" for 5 seconds.  
Temperature can be adjusted under smart dehumidification with cooling mode.
- The humidity for smart dehumidification is automatically adjusted according to human body comfort; no need to set the humidity manually.
- Under dry mode, press this button can select humidity control with dehumidification mode, continuous dehumidification mode, general dehumidification mode, and they can be set to operate circularly.



- When humidity control with dehumidification mode is set, the remote controller will display "☺", "%", and humidity value "88"; you can press "+" and "-" buttons to set the humidity value. Humidity setting range for the remote controller: 30%-70%. Temperature can't be adjusted under humidity control with dehumidification mode.

- When continuous dehumidification is set, the remote controller will display "☺"; the remote controller and indoor unit will display "Co".

Temperature can't be adjusted under continuous dehumidification mode.

- Under continuous dehumidification mode, the unit always works under dehumidification status; no need to set temperature and humidity.

**NOTE:**

- The air conditioner is mainly used for controlling the temperature, while the humidity control is the auxiliary function. The humidity will be affected by the factors such as indoor and outdoor environment, degree of indoor sealing and indoor flow.
- When the set humidity is higher than current atmospheric humidity, the set humidity can't be reached.
- If the humidity sensor is with malfunction, humidity setting under cooling mode or dehumidification mode will stop and the unit operates under general cooling mode or dehumidification mode.

LR-swing button

Press this button can select left & right swing angle. Fan blow angle can be selected circularly as below:

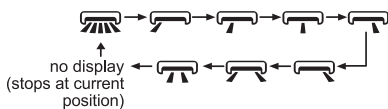

**NOTE:**

- Press this button continuously more than 2s, the main unit will swing back and forth from left to right, and then loosen the button, the unit will stop swinging and present position of guide louver will be kept immediately.
- Under swing left and right mode, when the status is switched from off to , if press this button again 2s later, status will switch to off status directly; if press this button again within 2s, the change of swing status will also depend on the circulation sequence stated above.
- This function only applicable for some models.

Timer button

- At ON status, press this button once can set TIMER OFF. The character of HOUR and OFF will flash. Press "+" or "-" button within 5s can adjust the time of TIMER OFF. After each pressing of "+" or "-" button, time will increase or decrease half an hour. When holding "+" or "-" button, 2s later, the time will change quickly until to reach to your required time. After that, press "Timer" button to confirm it. The character of HOUR and OFF won't flash again. Cancel TIMER OFF: Press "Timer" button again under TIMER

OFF status.

- At OFF status, press this button once can set TIMER ON. Please refer to TIMER off for detailed operation.

Cancel TIMER ON: Press "Timer" button again under TIMER ON status.

**NOTE:**

- Time setting range: 0.5-24 hours.
- Time interval between two operations can't exceed 5s. Otherwise, remote controller will exit the setting status automatically.

Sleep button

Press this button, can select Sleep 1 (☺), Sleep 2 (☺), Sleep 3 (☺) and cancel the Sleep, circulate between these, after electrified, Sleep Cancel is defaulted.

- Sleep 1 is Sleep mode 1, in Cool modes: sleep status after run for one hour, the main unit setting temperature will increase 1, two hours, setting temperature increased 2, then the unit will run at this setting temperature; In Heat mode: sleep status after run for one hour, the setting temperature will decrease 1, two hours, setting temperature will decrease 2, then the unit will run at this setting temperature.
- Sleep 2 is sleep mode 2, that is air conditioner will run according to the presetting a group of sleep temperature curve.
- Sleep 3 the sleep curve setting under Sleep mode by DIY;

(1) Under Sleep 3 mode, press "Health" button for a long time, remote controller enters into user individuation sleep setting status, at this time, the time of remote controller will display "1HOUR", the setting temperature "88" will display the corresponding temperature of last setting sleep curve and blink (The first entering will display according to the initial curve setting value of original factory);

(2) Adjust "+" and "-" button, could change the corresponding setting temperature, after adjusted, press "Health" button for confirmation;

(3) At this time, 1hour will be automatically increased at the timer position on the remote control, (that are "2HOUR" or "3HOUR" or "8HOUR"), the place of setting temperature "88" will display the corresponding temperature of last setting sleep curve and blink;

(4) Repeat the above step (2)~(3) operation, until 8 hours temperature setting finished, sleep,curve setting finished, at this time, the remote controller will resume the original timer display; temperature display will resume to original setting temperature.

- Sleep 3 the sleep curve setting under Sleep mode by DIY could be inquired:

The user could accord to sleep curve setting method to inquire the presetting sleep curve, enter into user individuation sleep setting status, but do not change the temperature, press "Health" button directly for confirmation. Note: In the above presetting or enquiry procedure, if continuously within 10s, there is no button pressed, the sleep curve setting within 10s, there is no button pressed, the sleep curve setting status will be automatically quit and resume to display the original displaying. In the presetting or enquiry procedure, press " On/Off " button, "Mode" button, "Timer" button or "Sleep" button, the sleep curve setting or enquiry status will quit similarly.

Light button

Press this button to control the LED status on the display, the circulation change is as follow:

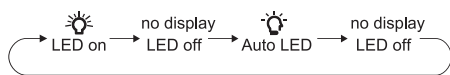

When selecting "  " (Auto LED) with remote controller, LED indicator on indoor unit will adjust the luminance automatically according to the ambient intensity of illumination.

## Function introduction for combination buttons

### Energy-saving function



Under cooling mode, press "Mode" and "Timer" buttons simultaneously to start up or turn off energy-saving function. When energy-saving function is started up, "SE" will be shown on remote controller, and air conditioner will adjust the set temperature automatically according to ex-factory setting to reach to the best energy-saving effect.

Press "Mode" and "Timer" buttons simultaneously again to exit energy-saving function.

#### NOTE:

- Under energy-saving function, fan speed is defaulted at auto speed and it can't be adjusted.
- Under energy-saving function, set temperature can't be adjusted.
- Sleep function and energy-saving function can't operate at the same time. If energy-saving function has been set under cool mode, press "Sleep" button will cancel energy-saving function. If sleep function has been set under cool mode, start up the energy-saving function will cancel sleep function.

### Child lock function

Hold " On/Off " and " - " buttons simultaneously for 3s to turn on or turn off child lock function. When child lock function is on, "  " icon is displayed on remote controller. If you operate the remote controller, the "  " icon will blink three times without sending signal to the unit.



### Temperature display switchover function

Under OFF status, hold "Mode" and " - " buttons simultaneously for 3s to switch temperature display between °C and °F.

### function

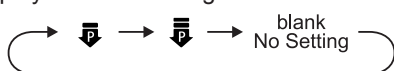
 function is for limiting power of the whole unit. Press "Mode" and "Sleep" buttons simultaneously, the remote controller will circularly display as the following:



- Maximum power limited under the  mode is lower than that of  mode.
- If you want to cancel the power limiting function, press "Mode" and "Sleep" buttons simultaneously till the icon in remote controller is not displayed.

• When the remote controller is turned off, power limiting function is cancelled. If you want to activate the function, please repress "Mode" and "Sleep" buttons simultaneously.

• If the current power is lower than the maximum power of  mode, then the power will not be limited after entering into such mode.

• For the model with one outdoor unit and two indoor units, if any one of indoor units enters into power limiting function, the outdoor unit will enter into the set limiting power mode of indoor unit; when two indoor units enter into power limiting mode, then the power of outdoor unit will be limited according to the lower power of the two indoor units.



#### NOTE:

- This button is only available for the model with such function.

### Indoor ambient temperature or humidity display

By holding " On/Off " and "  " buttons simultaneously, you can see indoor ambient temperature or indoor ambient humidity on indoor unit's display. The setting on remote controller is selected circularly as below:





- When selecting "  " with remote controller, temperature indicator on indoor unit displays indoor ambient temperature.
- When selecting "  " with remote controller, temperature indicator on indoor unit displays indoor ambient humidity.

#### NOTE:

- The ambient humidity value is only for reference. Eg: If humidity value is "0%", there may be malfunction for the humidity detection board. Please contact local service provider.
- There may be some measuring deviation for humidity detection and photosensitiveness detection.

### Clean reminder function of filter

The reminder function is defaulted to be OFF. Hold " On/Off " and "  " buttons simultaneously for 5s to turn it on. The buzzer will give out sound for 0.5s and the dual-8 nixie tube on the display will be on for 3s; Once the reminder function is turned on, when the air conditioner has reached to the set time, the dual-8 nixie tube will flash about 30s when the unit is turned on each time to remind the user to clean the filter; you can turn off this cycle reminder by holding " On/Off " and "  " buttons simultaneously for 5s and then the air conditioner will count time again.

#### NOTE:

- Once the reminder function is turned on, only this cycle reminder can be cleared.
- This function is only available for some models.

### Volume control of IDU Buzzer

Press "Mode" and "  " buttons simultaneously to reduce the sound level of the indoor unit' buzzer.

#### NOTE:

- This function is only available for some models.

### Fast cool function

Press " On/Off " and " + " buttons simultaneously under cooling mode can select 25°C(77°F) fast cooling mode, 16°C(61°F) fast cooling mode and normal cooling mode circularly. " " icon will be displayed on the remote controller under fast cooling mode.

Once it enters into fast cooling mode, the fan speed is auto fan and the set temperature is 25°C(77°F) or 16°C(61°F). At this time, the set temperature flashes to display for 5s. In the flashing period, press " + " or " - " button to adjust the set temperature.

Press "Fan" button to adjust the fan speed. If the set temperature and the fan speed haven't been adjusted during that time, the remote controller and the indoor unit will operate under current set temperature and fan speed for 20 minutes. 20 minutes later, the set temperature and the fan speed for the remote controller and the indoor unit will turn to the status before quick cooling.

**NOTE:**

- If the set temperature and the fan speed have been adjusted during the operation under fast cooling mode, the unit will exit from the fast cooling mode. Then the indoor unit operates continuously under the adjusted status.
- Fast cooling function is only applicable for some models. If this function is unavailable for this indoor unit, 20 minutes later, the remote controller will turn back to the status before fast cooling. Indoor unit operates continuously according to current status. At this time, status of indoor unit and the display status on the remote controller may be different.
- This function is only available for some models.

**Auto clean function**

Under unit off status, hold "Mode" and " " buttons simultaneously for 5s to turn on or turn off the auto clean function. When the auto clean function is turned on, indoor unit displays "CL" . During the auto clean process of evaporator, the unit will perform fast cooling or fast heating. There may be some noise, which is the sound of flowing liquid or thermal expansion or cold shrinkage. The air conditioner may blow cool or warm air, which is a normal phenomenon. During cleaning process, please make sure the room is well ventilated to avoid affecting the comfort.

**NOTE:**

- The auto clean function can only work under normal ambient temperature. If the room is dusty, clean it once a month; if not, clean it once every three months. After the auto clean function is turned on, you can leave the room. When auto clean is finished, the air conditioner will enter standby status.
- This function is only available for some models.

**Night mode**

Under cooling or heating mode, when turning on sleep mode and turn to low speed or quiet notch, the outdoor unit would enter into night mode.

**NOTE:**

- When you feel that the cooling and heating effect is poor, please press "Fan" button to other fan speed or press "Sleep" button to exit the night mode.
- The night mode can only work under normal ambient temperature.
- This function is only available for some models.

**I FEEL function**

Press "Health" and " + " buttons simultaneously to start I FEEL function and " " will be displayed on the remote controller. After this function is set, the remote controller will send the detected ambient temperature to the controller and the unit will automatically adjust the indoor temperature according to the detected temperature. Press "Health" and " + " buttons simultaneously again to turn off I FEEL function and " " will disappear.

- Please put the remote controller near user when this function is set. Do not put the remote controller near the object of high temperature or low temperature in order to avoid detecting inaccurate ambient temperature. When I FEEL function is turned on, the remote controller should be put within the area where indoor unit can receive the signal sent by the remote controller.

**Replacement of batteries in remote controller**

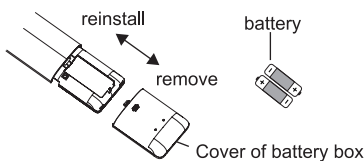

1. Press the back side of remote controller marked with " " , as shown in the fig, and then push out the cover of battery box along the arrow direction.
2. Replace two 7# (AAA 1.5V) dry batteries, and make sure the position of "+" polar and "-" polar are correct.
3. Reinstall the cover of battery box.

**NOTICE:**

- During operation, point the remote control signal sender at the receiving window on indoor unit.
- The distance between signal sender and receiving window should be no more than 8m, and there should be no obstacles between them.
- Signal may be interfered easily in the room where there is fluorescent lamp or wireless telephone; remote controller should be close to indoor unit during operation.
- Replace new batteries of the same model when replacement is required.
- When you don't use remote controller for a long time, please take out the batteries.
- If the display on remote controller is fuzzy or there's no display, please replace batteries.

## 6.3 GREE+ App Operation Manual

### Control Flow Chart

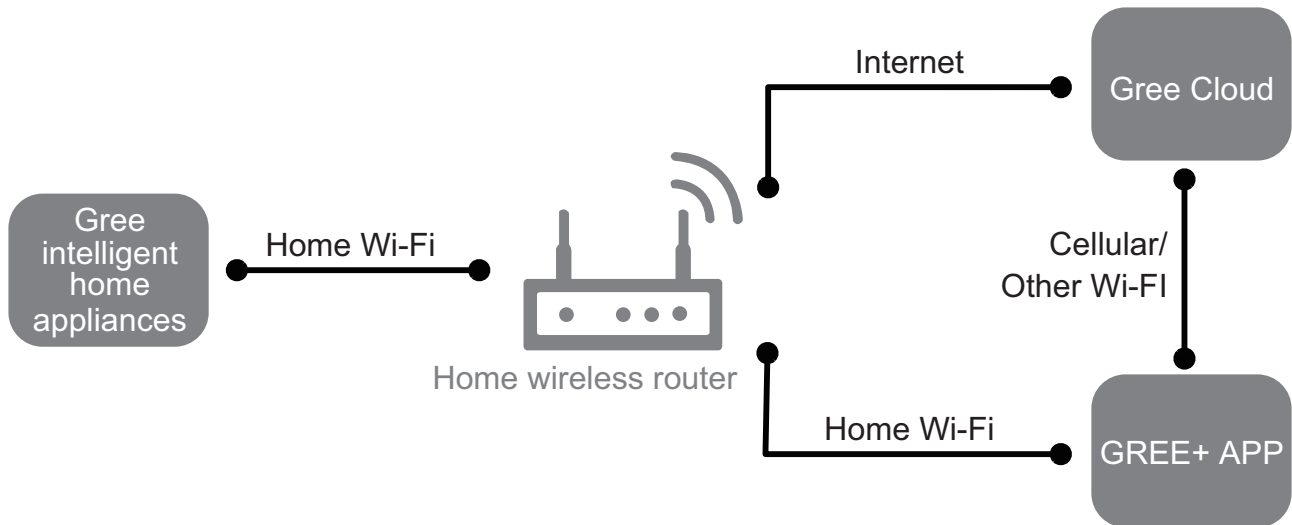

### Operating Systems

Requirement for User's smart phone:



iOS system  
Support iOS7.0 and  
above version



Android system  
Support Android 4.4 and  
above version

### Download and installation



GREE+ App Download Linkage

Scan the QR code or search "GREE+" in the application market to download and install it. When "GREE+" App is installed, register the account and add the device to achieve long-distance control and LAN control of Gree smart home appliances. For more information, please refer to "Help" in App.

## 6.4 Ewpe Smart App Operation Manual

### Control Flow Chart

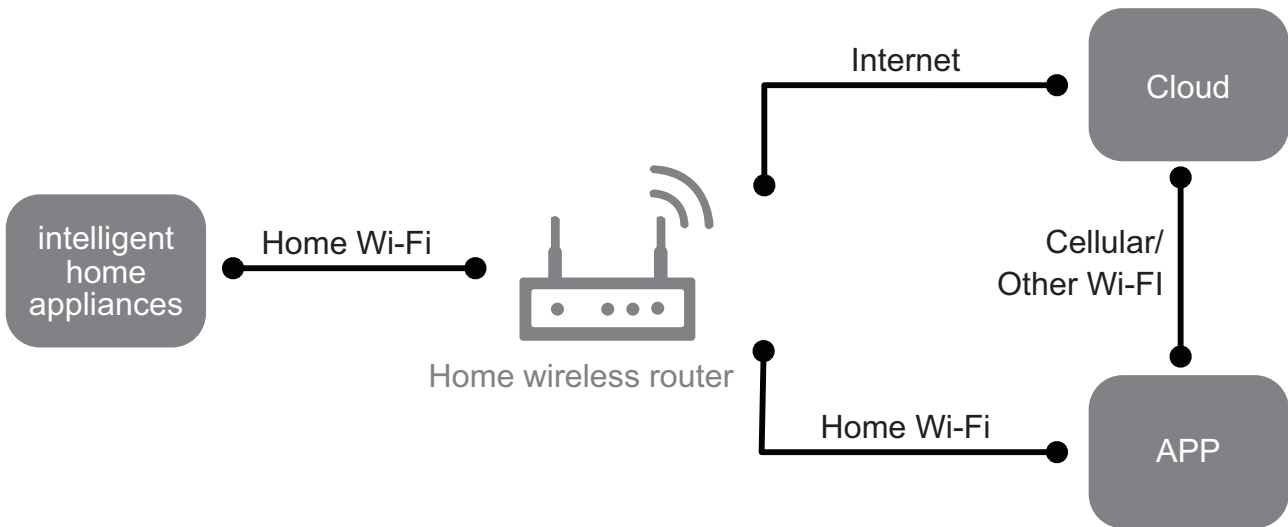

### Operating Systems

Requirement for User's smart phone:



iOS system  
Support iOS7.0 and  
above version



Android system  
Support Android 4.4 and  
above version

### Download and installation



App Download Linkage

Scan the QR code or search "Ewpe Smart" in the application market to download and install it. When "Ewpe Smart" App is installed, register the account and add the device to achieve long-distance control and LAN control of smart home appliances. For more information, please refer to "Help" in App.

## 6.5 Brief Description of Models and Functions

### ●Indoor Unit

#### 1.Basic function of system

##### (1)Cooling mode

(1) Under this mode, fan and swing operates at setting status. Temperature setting range is 16~30°C.

(2) During malfunction of outdoor unit or the unit is stopped because of protection, indoor unit keeps original operation status.

##### (2)Drying mode

(1) Under this mode, fan operates at low speed and swing operates at setting status. Temperature setting range is 16~30°C.

(2) During malfunction of outdoor unit or the unit is stopped because of protection, indoor unit keeps original operation status.

(3) Protection status is same as that under cooling mode.

(4) Sleep function is not available for drying mode.

##### (3)Heating mode

(1) Under this mode, Temperature setting range is 16~30°C.

(2) Working condition and process for heating mode:

When turn on the unit under heating mode, indoor unit enters into cold air prevention status. When the unit is stopped or at OFF status, and indoor unit has been started up just now, the unit enters into residual heat-blowing status.

##### (4)Working method for AUTO mode:

1.Working condition and process for AUTO mode:

a.Under AUTO mode, standard heating  $T_{\text{preset}}=20^{\circ}\text{C}$  and standard cooling  $T_{\text{preset}}=25^{\circ}\text{C}$ . The unit will switch mode automatically according to ambient temperature.

2.Protection function

a. During cooling operation, protection function is same as that under cooling mode.

b. During heating operation, protection function is same as that under heating mode.

3. Display: Set temperature is the set value under each condition. Ambient temperature is ( $T_{\text{amb.}} - T_{\text{compensation}}$ ) for heat pump unit and  $T_{\text{amb.}}$  for cooling only unit.

4. If theres I feel function, Tcompensation is 0. Others are same as above.

##### (5)Fan mode

Under this mode, indoor fan operates at set fan speed. Compressor, outdoor fan, 4-way valve and electric heating tube stop operation. Indoor fan can select to operate at high, medium, low or auto fan speed. Temperature setting range is 16~30°C.

#### 2. Other control

##### (1) Buzzer

Upon energization or availably operating the unit or remote controller, the buzzer will give out a beep.

##### (2) Auto button

If press this auto button when turning off the unit, the complete unit will operate at auto mode. Indoor fan operates at auto fan speed and swing function is turned on. Press this auto button at ON status to turn off the unit.

##### (3) Auto fan

Heating mode: During auto heating mode or normal heating ode, auto fan speed will adjust the fan speed automatically according to ambient temperature and set temperature.

##### (4) Sleep

After setting sleep function for a period of time, system will adjust set temperature automatically.

##### (5) Timer function:

General timer and clock timer functions are compatible by equipping remote controller with different functions.

##### (6) Memory function

memorize compensation temperature, off-peak energization value. Memory content: mode, up&down swing, light, set temperature, set fan speed, general timer (clock timer can't be memorized).

After power recovery, the unit will be turned on automatically according to memory content.

##### (7) Health function

During operation of indoor fan, set health function by remote controller. Turn off the unit will also turn off health function.

Turn on the unit by pressing auto button, and the health is defaulted ON.

##### (8)I feel control mode

After controller received I feel control signal and ambient temperature sent by remote controller, controller will work according to the ambient temperature sent by remote controller.

##### (9)Entry condition for compulsory defrosting function

When turn on the unit under heating ode and set temperature is 16°C (or 16.5°C by remote controller), press "+, -, +, -, +, -"button successively within 5s and then indoor unit will enter into compulsory defrosting setting status:

(1) If theres only indoor units controller, it enters into indoor normal defrosting mode.

(2) If theres indoor units controller and outdoor units controller, indoor unit will send compulsory defrosting mode signal to outdoor unit and then outdoor unit will operate under normal defrosting mode. After indoor unit received the signal that outdoor unit has entered into defrosting status, indoor unit will cancel to send compulsory mode to outdoor unit. If outdoor unit hasn't received feedback signal from outdoor unit after 3min, indoor unit will also cancel to send compulsory defrosting signal.

##### (10)Refrigerant recovery function:

Enter into Freon recovery mode actively: Within 5min after energization, turn on the unit at 16°C under cooling mode, and press light button for 3 times within 3s to enter into Freon recovery mode. Fo is displayed and Freon recovery mode will be sent to outdoor unit.

##### (11)Ambient temperature display control mode

1. When user set the remote controller to display set temperature (corresponding remote control code: 01), current set temperature will be displayed.

2. Only when remote control signal is switched to indoor ambient temperature display status (corresponding remote control code: 10) from other display status (corresponding remote control code: 00, 01,11),controller will display indoor ambient temperature for 3s and then turn back to display set temperature.

Under this mode, indoor fan operates at set fan speed. Compressor, outdoor fan, 4-way valve and electric heating tube stop operation. Indoor fan can select to operate at high, medium, low or auto fan speed. Temperature setting range is 16~30°C.

##### (12)Off-peak energization function:

Adjust compressors minimum stop time. The original minimum stop time is 180s and then we change to:

The time interval between two start-ups of compressor can't be less than  $180+T_s(0\leq T_s\leq 15)$ . T is the variable of controller. Thats to say the minimum stop time of compressor is 180s~195s. Read-in T into memory chip when refurbish the memory chip each time.

After power recovery, compressor can only be started up after  $180+T$  s at least.

### (13) SE control mode

The unit operates at SE status.

### (14) X-fan mode

When X-fan function is turned on, after turn off the unit, indoor fan will still operate at low speed for 2min and then the complete unit will be turned off. When x-fan function is turned off, after turn off the unit, the complete unit will be turned off directly.

### (15) 8°C heating function

Under heating mode, you can set 8°C heating function by remote controller. The system will operate at 8°C set temperature.

### (16) Turbo function

Turbo function can be set under cooling and heating modes. Press Fan Speed button to cancel turbo setting. Turbo function is not available under auto, drying and fan modes.

## ●Outdoor Unit

### 1. Cooling mode:

Working condition and process of cooling mode:

- ① When  $T_{\text{indoor ambient temperature}} \geq T_{\text{preset}}$ , unit enters into cooling mode. Indoor fan, outdoor fan and compressor start operation. Indoor fan operates according to set fan speed.
- ② When  $T_{\text{indoor ambient temperature}} \leq T_{\text{preset}} - 2^{\circ}\text{C}$ , compressor stops operation and outdoor fan will stop 30s later. Indoor fan operates according to set fan speed.
- ③ When  $T_{\text{preset}} - 2^{\circ}\text{C} < T_{\text{indoor ambient temperature}} < T_{\text{preset}}$ , unit operates according to the previous status.

Under cooling mode, 4-way valve is not energized. Temperature setting range is 16~30°C. If compressor stops because of malfunction in cooling mode, indoor fan and swing motor will work according to the original status.

### 2. Drying mode

(1) Working condition and process of drying mode

- ① When  $T_{\text{indoor ambient temperature}} > T_{\text{preset}}$ , unit will be in drying mode. Outdoor fan and compressor start operation while indoor fan will operate at low fan speed.
- ② When  $T_{\text{preset}} - 2^{\circ}\text{C} \leq T_{\text{indoor ambient temperature}} \leq T_{\text{preset}}$ , unit operates according to the previous status.
- ③ When  $T_{\text{indoor ambient temperature}} < T_{\text{preset}} - 2^{\circ}\text{C}$ , compressor stops operation and outdoor fan will stop 30s later.

(2) Under drying mode, 4-way valve is not energized. Temperature setting range is 16~30°C.

(3) Protection function: same as in cooling mode.

### 3. Fan mode

(1) Under this mode, indoor fan can select different fan speed (except Turbo) or auto fan speed. Compressor, outdoor fan and 4-way valve all stop operation.

(2) In fan mode, temperature setting range is 16~30°C.

### 4. Heating mode

Working condition and process of heating mode:

- ① When  $T_{\text{preset}} - (T_{\text{indoor ambient temperature}} - T_{\text{compensation}}) \geq 1^{\circ}\text{C}$ , unit enters into heating mode. Compressor, outdoor fan and 4-way valve start operation.
- ② When  $-2^{\circ}\text{C} < T_{\text{preset}} - (T_{\text{indoor ambient temperature}} - T_{\text{compensation}}) < 1^{\circ}\text{C}$ , unit operates according to the previous status.
- ③ When  $T_{\text{preset}} - (T_{\text{indoor ambient temperature}} - T_{\text{compensation}}) \leq -2^{\circ}\text{C}$ , compressor

stops operation and outdoor fan will stop 30s later. Indoor fan will be in residual-heat blowing status.

④ When unit is turned off under heating mode or changed to other modes from heating mode, 4-way valve will be power-off 2min after compressor stops working (compressor is in operation status under heating mode).

⑤ When  $T_{\text{outdoor ambient temperature}} > 30^{\circ}\text{C}$ , compressor stops operation immediately. Outdoor fan will stop 30s later.

⑥ Under the condition that compressor is turned on, when unit is changed to heating mode from cooling or drying mode, 4-way valve will be energized in 2~3mins delay.

Note: Tcompensation is determined by IDU and ODU. If IDU controls the compensation temperature, then Tcompensation is determined according to the value sent by IDU to ODU; If IDU does not control the compensation temperature, then Tcompensation will default to 3°C by the ODU.

### 5. Freon recovery mode

After the Freon recovery signal from IDU is received, cooling at rated frequency will be forcibly turned on to recover Freon.

Indoor unit will display Fo. If any signal from remote controller is received, unit will exit from Freon recovery mode and indoor unit stops displaying Fo.

### 6. Compulsory defrosting

If unit is turned on under heating mode and set temperature is 16°C (by remote controller), press "+, -, +, -, +, -" within 5s, unit will enter into compulsory defrosting mode and send the signal to ODU. When the compulsory defrosting signal from ODU is received, IDU will exit from the compulsory defrosting mode and stop sending the signal to ODU.

After ODU receives the compulsory defrosting code, it will start compulsory defrosting. Defrosting frequency and opening angle will be the same as in normal defrosting mode. When compulsory defrosting is finished, the complete unit resumes original status.

### 7. Auto mode

Auto mode is determined by controller of IDU. See IDU logic for details.

### 8. 8°C heating

Set temperature is 8°C. Display board of IDU displays 8°C. Under this mode, "Cold air prevention" function is shielded.

If compressor is operating under this mode, fan speed will adjust according to auto fan speed; if compressor stops operation under this mode, indoor fan will be in residual-heat blowing status.

**When power on, communication light will be blinking in a normal way (after receiving a group of correct signals, blinking stops for 0.2s~0.3s). If theres no communication, communication light will be always on. If other ODU has malfunction, communication light will be on for 1s and off for 1s in a circular way.**



# 7. Notes for Installation and Maintenance

## Safety Precautions: Important!

Please read the safety precautions carefully before installation and maintenance.

The following contents are very important for installation and maintenance.

Please follow the instructions below.

- The installation or maintenance must accord with the instructions.
- Comply with all national electrical codes and local electrical codes.
- Pay attention to the warnings and cautions in this manual.
- All installation and maintenance shall be performed by distributor or qualified person.
- All electric work must be performed by a licensed technician according to local regulations and the instructions given in this manual.
- Be caution during installation and maintenance. Prohibit incorrect operation to prevent electric shock, casualty and other accidents.

## WARNINGS

### Electrical Safety Precautions:

1. Cut off the power supply of air conditioner before checking and maintenance.
2. The air condition must apply specialized circuit and prohibit share the same circuit with other appliances.
3. The air conditioner should be installed in suitable location and ensure the power plug is touchable.
4. Make sure each wiring terminal is connected firmly during installation and maintenance.
5. Have the unit adequately grounded. The grounding wire can't be used for other purposes.
6. Must apply protective accessories such as protective boards, cable-cross loop and wire clip.
7. The live wire, neutral wire and grounding wire of power supply must be corresponding to the live wire, neutral wire and grounding wire of the air conditioner.
8. The power cord and power connection wires can't be pressed by hard objects.
9. If power cord or connection wire is broken, it must be replaced by a qualified person.
10. If the power cord or connection wire is not long enough, please get the specialized power cord or connection wire from the manufacture or distributor. Prohibit prolong the wire by yourself.
11. For the air conditioner without plug, an air switch must be installed in the circuit. The air switch should be all-pole parting and the contact parting distance should be more than 3mm.

12. Make sure all wires and pipes are connected properly and the valves are opened before energizing.
13. Check if there is electric leakage on the unit body. If yes, please eliminate the electric leakage.
14. Replace the fuse with a new one of the same specification if it is burnt down; don't replace it with a cooper wire or conducting wire.
15. If the unit is to be installed in a humid place, the circuit breaker must be installed.

### Installation Safety Precautions:

1. Select the installation location according to the requirement of this manual.(See the requirements in installation part)
2. Handle unit transportation with care; the unit should not be carried by only one person if it is more than 20kg.
3. When installing the indoor unit and outdoor unit, a sufficient fixing bolt must be installed; make sure the installation support is firm.
4. Ware safety belt if the height of working is above 2m.
5. Use equipped components or appointed components during installation.
6. Make sure no foreign objects are left in the unit after finishing installation.

### Refrigerant Safety Precautions:

1. When refrigerant leaks or requires discharge during installation, maintenance, or disassembly, it should be handled by certified professionals or otherwise in compliance with local laws and regulations.
- 2.Avoid contact between refrigerant and fire as it generates poisonous gas; Prohibit prolong the connection pipe by welding.
3. Apply specified refrigerant only. Never have it mixed with any other refrigerant. Never have air remain in the refrigerant line as it may lead to rupture or other hazards.
4. Make sure no refrigerant gas is leaking out when installation is completed.
5. If there is refrigerant leakage, please take sufficient measure to minimize the density of refrigerant.
6. Never touch the refrigerant piping or compressor without wearing glove to avoid scald or frostbite.

**Improper installation may lead to fire hazard, explosion, electric shock or injury.**

## Safety Precautions for Installing and Relocating the Unit:

To ensure safety, please be mindful of the following precautions.

### WARNINGS

**1. When installing or relocating the unit, be sure to keep the refrigerant circuit free from air or substances other than the specified refrigerant.**

Any presence of air or other foreign substance in the refrigerant circuit will cause system pressure rise or compressor rupture, resulting in injury.

**2. When installing or moving this unit, do not charge the refrigerant which is not comply with that on the nameplate or unqualified refrigerant.**

Otherwise, it may cause abnormal operation, wrong action, mechanical malfunction or even series safety accident.

**3. When refrigerant needs to be recovered during relocating or repairing the unit, be sure that the unit is running in cooling mode. Then, fully close the valve at high pressure side (liquid valve). About 30-40 seconds later, fully close the valve at low pressure side (gas valve), immediately stop the unit and disconnect power. Please note that the time for refrigerant recovery should not exceed 1 minute.**

If refrigerant recovery takes too much time, air may be sucked in and cause pressure rise or compressor rupture, resulting in injury.

**4. During refrigerant recovery, make sure that liquid valve and gas valve are fully closed and power is disconnected before detaching the connection pipe.**

If compressor starts running when stop valve is open and connection pipe is not yet connected, air will be sucked in and cause pressure rise or compressor rupture, resulting in injury.

**5. When installing the unit, make sure that connection pipe is securely connected before the compressor starts running.**

If compressor starts running when stop valve is open and connection pipe is not yet connected, air will be sucked in and cause pressure rise or compressor rupture, resulting in injury.

**6. Prohibit installing the unit at the place where there may be leaked corrosive gas or flammable gas.**

If there leaked gas around the unit, it may cause explosion and other accidents.

**7. Do not use extension cords for electrical connections. If the electric wire is not long enough, please contact a local service center authorized and ask for a proper electric wire.**

Poor connections may lead to electric shock or fire.

**8. Use the specified types of wires for electrical connections between the indoor and outdoor units. Firmly clamp the wires so that their terminals receive no external stresses.**

Electric wires with insufficient capacity, wrong wire connections and insecure wire terminals may cause electric shock or fire.

## Safety Precautions for Refrigerant

- To realize the function of the air conditioner unit, a special refrigerant circulates in the system. The used refrigerant is the fluoride R32, which is specially cleaned. The refrigerant is flammable and inodorous. Furthermore, it can lead to explosion under certain conditions. But the flammability of the refrigerant is very low. It can be ignited only by fire.
- Compared to common refrigerants, R32 is a nonpolluting refrigerant with no harm to the ozonosphere. The influence upon the greenhouse effect is also lower. R32 has got very good thermodynamic features which lead to a really high energy efficiency. The units there fore need a less filling.

### WARNING:

Do not use means to accelerate the defrosting process or to clean, other than those recommended by the manufacture. Should repair be necessary, contact your nearest authorized Service Centre. Any repairs carried out by unqualified personnel may be dangerous. The appliance shall be stored in a room without continuously operating ignition sources. (for example: open flames, an operating gas appliance or an operating electric heater.) Do not pierce or burn.

Appliance shall be installed, operated and stored in a room with a floor area larger than  $Xm^2$ . (Please refer to table "a" in section of " Safety operation of flammable refrigerant " for space X.)

Appliance filled with flammable gas R32.

For repairs, strictly follow manufacturer's instructions only. Be aware that refrigerants may not contain an odour. Read specialist's manual.



## Safety Operation of Flammable Refrigerant

### Qualification requirement for installation and maintenance man

- All the work men who are engaging in the refrigeration system should bear the valid certification awarded by the authoritative organization and the qualification for dealing with the refrigeration system recognized by this industry. If it needs other technician to maintain and repair the appliance, they should be supervised by the person who bears the qualification for using the flammable refrigerant.
- It can only be repaired by the method suggested by the equipment's manufacturer.

### Installation notes

- The air conditioner must be installed in a room that is larger

than the minimum room area. The minimum room area is shown on the nameplate or following table a.

- It is not allowed to drill hole or burn the connection pipe.
- Leak test is a must after installation.

table a - Minimum room area (  $m^2$  )

Charge amount (kg)	Floor location	Window mounted	Wall mounted	Ceiling mounted
≤1.2	4	4	4	4
1.3	14.5	5.2	4	4
1.4	16.8	6.1	4	4
1.5	19.3	7	4	4
1.6	22	7.9	4	4
1.7	24.8	8.9	4	4
1.8	27.8	10	4	4
1.9	31	11.2	4	4
2.0	34.3	12.4	4	4
2.1	37.8	13.6	4.2	4
2.2	41.5	15	4.6	4
2.3	45.4	16.3	5	4
2.4	49.4	17.8	5.5	4
2.5	53.6	19.3	6	4

### Maintenance notes

- Check whether the maintenance area or the room area meet the requirement of the nameplate.
  - It's only allowed to be operated in the rooms that meet the requirement of the nameplate.
- Check whether the maintenance area is wellventilated.
  - The continuous ventilation status should be kept during the operation process.
- Check whether there is fire source or potential fire source in the maintenance area.
  - The naked flame is prohibited in the maintenance area; and the "no smoking" warning board should be hanged.
- Check whether the appliance mark is in good condition.
  - Replace the vague or damaged warning mark.

### Welding

- If you should cut or weld the refrigerant system pipes in the process of maintaining, please follow the steps as below:
  - a. Shut down the unit and cut power supply
  - b. Eliminate the refrigerant
  - c. Vacuuming
  - d. Clean it with  $N_2$  gas
  - e. Cutting or welding
  - f. Carry back to the service spot for welding
    - The refrigerant should be recycled into the specialized storage tank.
    - Make sure that there isn't any naked flame near the outlet of the vacuum pump and it's wellventilated.

## Filling the refrigerant

- Use the refrigerant filling appliances specialized for R32. Make sure that different kinds of refrigerant won't contaminate with each other.
- The refrigerant tank should be kept upright at the time of filling refrigerant.
- Stick the label on the system after filling is finished (or haven't finished).
- Don't overfilling.
- After filling is finished, please do the leakage detection before test running; another time of leak detection should be done when it's removed.

## Safety instructions for transportation and storage

- Please use the flammable gas detector to check before unload and open the container.
- No fire source and smoking.
- According to the local rules and laws.

## Specialist's Manual

- The following checks shall be applied to installations using flammable refrigerants:
  - the charge size is in accordance with the room size within which the refrigerant containing parts are installed;
  - the ventilation machinery and outlets are operating adequately and are not obstructed;
  - if an indirect refrigerating circuit is being used, the secondary circuit shall be checked for the presence of refrigerant;
  - marking to the equipment continues to be visible and legible. Markings and signs that are illegible shall be corrected;
  - refrigeration pipe or components are installed in a position where they are unlikely to be exposed to any substance which may corrode refrigerant containing components, unless the components are constructed of materials which are inherently resistant to being corroded or are suitably protected against being so corroded.
- Repair and maintenance to electrical components shall include initial safety checks and component inspection procedures. If a fault exists that could compromise safety, then no electrical supply shall be connected to the circuit until it is satisfactorily dealt with. If the fault cannot be corrected immediately but it is necessary to continue operation, an adequate temporary solution shall be used. This shall be reported to the owner of the equipment so all parties are advised.
- Initial safety checks shall include:
  - that capacitors are discharged: this shall be done in a safe manner to avoid possibility of sparking;
  - that no live electrical components and wiring are exposed while charging, recovering or purging the system;
  - that there is continuity of earth bonding.
- Checking for presence of refrigerant  
The area shall be checked with an appropriate refrigerant detector prior to and during work, to ensure the technician is aware of potentially toxic or flammable atmospheres. Ensure that the leak detection equipment being used is suitable for use with all applicable refrigerants, i.e. non-sparking, adequately sealed or intrinsically safe.
- Presence of fire extinguisher  
If any hot work is to be conducted on the refrigeration equipment or any associated parts, appropriate fire extinguishing equipment shall be available to hand. Have a dry powder or CO<sub>2</sub> fire

extinguisher adjacent to the charging area.

- Ventilated area  
Ensure that the area is in the open or that it is adequately ventilated before breaking into the system or conducting any hot work. A degree of ventilation shall continue during the period that the work is carried out. The ventilation should safely disperse any released refrigerant and preferably expel it externally into the atmosphere.
- Checks to the refrigeration equipment  
Where electrical components are being changed, they shall be fit for the purpose and to the correct specification. At all times the manufacturer's maintenance and service guidelines shall be followed. If in doubt, consult the manufacturer's technical department for assistance.
- Checks to electrical devices
  - that capacitors are discharged: this shall be done in a safe manner to avoid possibility of sparking;
  - that no live electrical components and wiring are exposed while charging, recovering or purging the system.
- Repairs to sealed components  
During repairs to sealed components, all electrical supplies shall be disconnected from the equipment being worked upon prior to any removal of sealed covers, etc. If it is absolutely necessary to have an electrical supply to equipment during servicing, then a permanently operating form of leak detection shall be located at the most critical point to warn of a potentially hazardous situation. Particular attention shall be paid to the following to ensure that by working on electrical components, the casing is not altered in such a way that the level of protection is affected. This shall include damage to cables, excessive number of connections, terminals not made to original specification, damage to seals, incorrect fitting of glands, etc.
  - Ensure that the apparatus is mounted securely.
  - Ensure that seals or sealing materials have not degraded to the point that they no longer serve the purpose of preventing the ingress of flammable atmospheres. Replacement parts shall be in accordance with the manufacturer's specifications.
- NOTE: The use of silicon sealant can inhibit the effectiveness of some types of leak detection equipment.  
Intrinsically safe components do not have to be isolated prior to working on them.
- Repair to intrinsically safe components  
Do not apply any permanent inductive or capacitance loads to the circuit without ensuring that this will not exceed the permissible voltage and current permitted for the equipment in use. Intrinsically safe components are the only types that can be worked on while live in the presence of a flammable atmosphere. The test apparatus shall be at the correct rating. Replace components only with parts specified by the manufacturer. Other parts may result in the ignition of refrigerant in the atmosphere from a leak.
- Cabling  
Check that cabling will not be subject to wear, corrosion, excessive pressure, vibration, sharp edges or any other adverse environmental effects. The check shall also take into account the effects of aging or continual vibration from sources such as compressors or fans.
- Detection of flammable refrigerants  
Under no circumstances shall potential sources of ignition be used in the searching for or detection of refrigerant leaks. A halide torch (or any other detector using a naked flame) shall not be used.
- Leak detection methods  
Leak detection fluids are suitable for use with most refrigerants but the use of detergents containing chlorine shall be avoided as the chlorine may react with the refrigerant and corrode the copper

pipe-work.

- Decommissioning

Before carrying out this procedure, it is essential that the technician is completely familiar with the equipment and all its detail. It is recommended good practice that all refrigerants are recovered safely. Prior to the task being carried out, an oil and refrigerant sample shall be taken in case analysis is required prior to re-use of reclaimed refrigerant. It is essential that electrical power is available before the task is commenced.

- a) Become familiar with the equipment and its operation.
- b) Isolate system electrically.
- c) Before attempting the procedure, ensure that:
  - mechanical handling equipment is available, if required, for handling refrigerant cylinders;
  - all personal protective equipment is available and being used correctly;
  - the recovery process is supervised at all times by a competent person;
  - recovery equipment and cylinders conform to the appropriate standards.
- d) Pump down refrigerant system, if possible.
- e) If a vacuum is not possible, make a manifold so that refrigerant can be removed from various parts of the system.
- f) Make sure that cylinder is situated on the scales before recovery takes place.
- g) Start the recovery machine and operate in accordance with manufacturer's instructions.
- h) Do not overfill cylinders. (No more than 80% volume liquid charge).
- i) Do not exceed the maximum working pressure of the cylinder, even temporarily.
- j) When the cylinders have been filled correctly and the process completed, make sure that the cylinders and the equipment are removed from site promptly and all isolation valves on the equipment are closed off.
- k) Recovered refrigerant shall not be charged into another refrigeration system unless it has been cleaned and checked.

- Labelling

Equipment shall be labelled stating that it has been decommissioned and emptied of refrigerant. The label shall be dated

and signed. For appliances containing flammable refrigerants, ensure that there are labels on the equipment stating the equipment contains flammable refrigerant.

- Recovery

When removing refrigerant from a system, either for servicing or decommissioning, it is recommended good practice that all refrigerants are removed safely.

When transferring refrigerant into cylinders, ensure that only appropriate refrigerant recovery cylinders are employed. Ensure that the correct number of cylinders for holding the total system charge are available.

All cylinders to be used are designated for the recovered refrigerant and labelled for that refrigerant (i.e. special cylinders for the recovery of refrigerant).

Cylinders shall be complete with pressure-relief valve and associated shut-off valves in good working order. Empty recovery cylinders are evacuated and, if possible, cooled before recovery occurs.

The recovery equipment shall be in good working order with a set of instructions concerning the equipment that is at hand and shall be suitable for the recovery of all appropriate refrigerants including, when applicable, flammable refrigerants. In addition, a set of calibrated weighing scales shall be available and in good working order. Hoses shall be complete with leak-free disconnect couplings and in good condition. Before using the recovery machine, check that it is in satisfactory working order, has been properly maintained and that any associated electrical components are sealed to prevent ignition in the event of a refrigerant release. Consult manufacturer if in doubt.

The recovered refrigerant shall be returned to the refrigerant supplier in the correct recovery cylinder, and the relevant waste transfer note arranged. Do not mix refrigerants in recovery units and especially not in cylinders.

If compressors or compressor oils are to be removed, ensure that they have been evacuated to an acceptable level to make certain that flammable refrigerant does not remain within the lubricant. The evacuation process shall be carried out prior to returning the compressor to the suppliers. Only electric heating to the compressor body shall be employed to accelerate this process. When oil is drained from a system, it shall be carried out safely.

## Main Tools for Installation and Maintenance



Level meter



Measuring tape



Screw driver



Impact drill



Drill head



Electric drill



Electroprobe



Universal meter



Torque wrench



Open-end wrench



Inner hexagon spanner



Electronic leakage detector



Vacuum pump



Pressure meter



Pipe pliers



Pipe pliers



Pipe cutter



Pipe expander



Pipe bender



Soldering appliance



Refrigerant container



Electronic scale

# 8. Installation

## 8.1 Installation Dimension Diagram

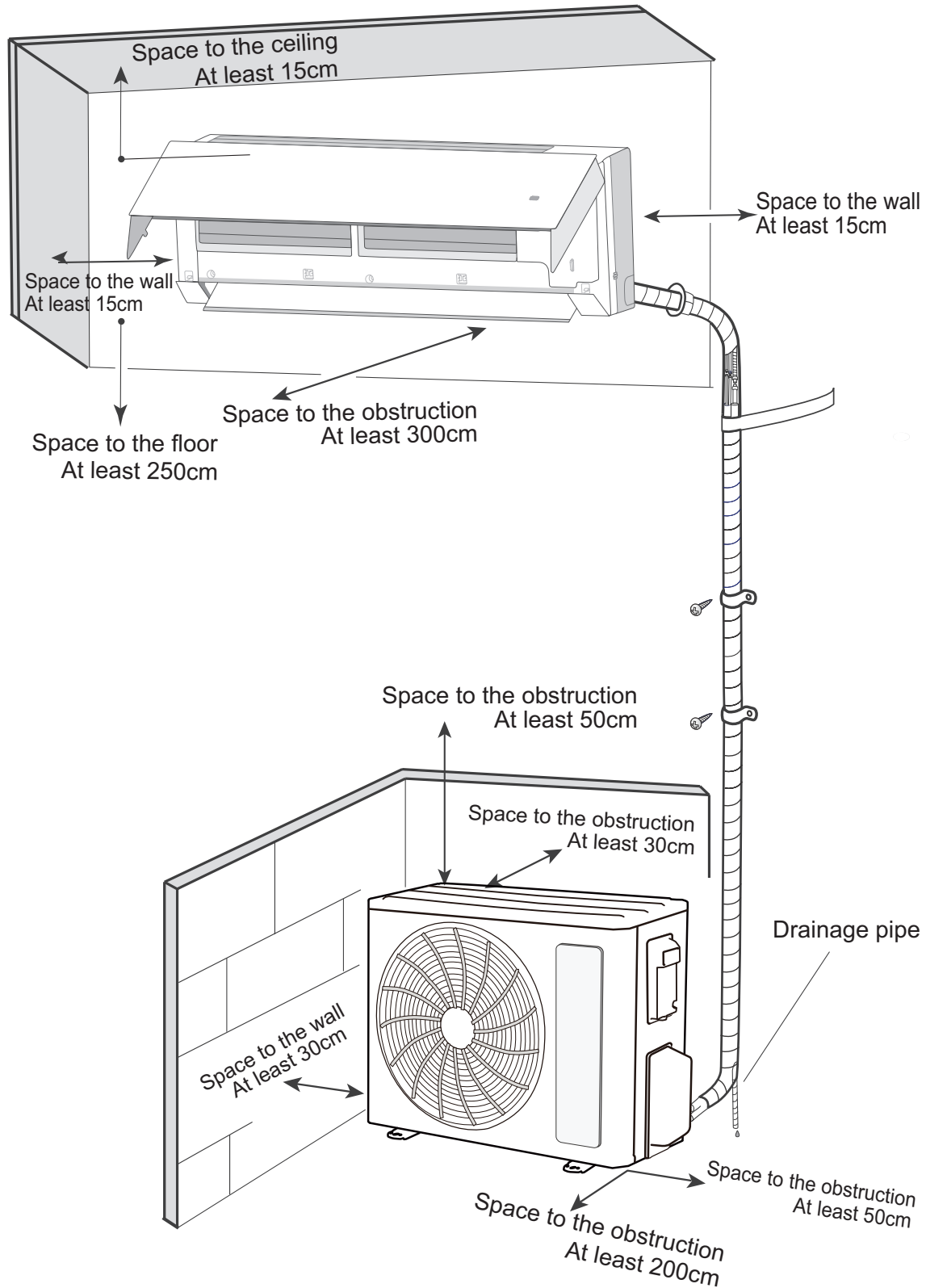

# Installation Procedures

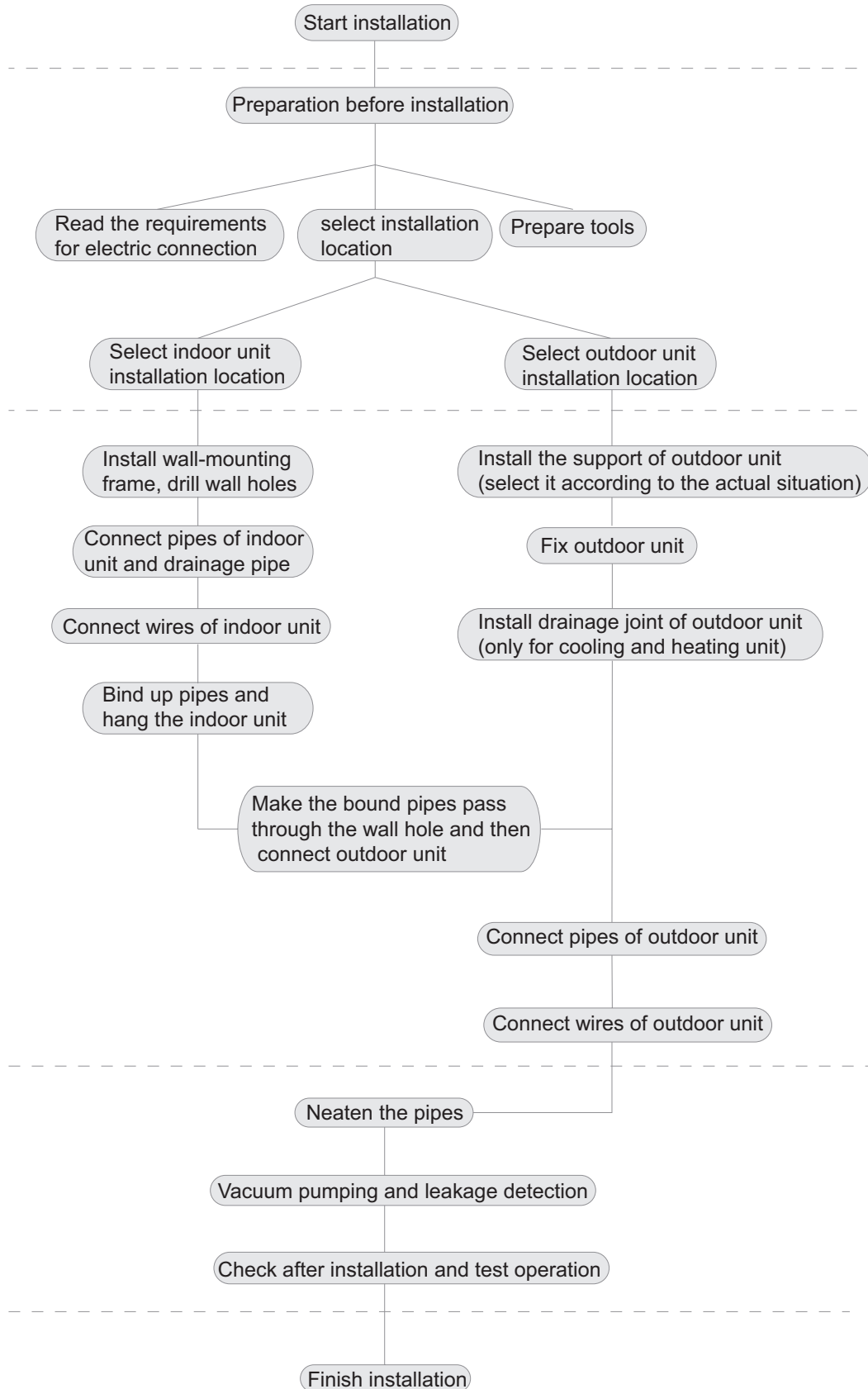

Note: this flow is only for reference; please find the more detailed installation steps in this section.



## 8.2 Installation Parts-checking

No.	Name
1	Indoor unit
2	Outdoor unit
3	Connection pipe
4	Drainage pipe
5	Wall-mounting frame
6	Connecting cable(power cord)
7	Wall pipe
8	Sealing gum
9	Wrapping tape
10	Support of outdoor unit
11	Fixing screw
12	Drainage plug(cooling and heating unit)
13	Owners manual, remote controller

### ⚠ Note:

- 1.Please contact the local agent for installation.
- 2.Don't use unqualified power cord.

## 8.3 Selection of Installation Location

### 1. Basic Requirement:

Installing the unit in the following places may cause malfunction. If it is unavoidable, please consult the local dealer:

- (1) The place with strong heat sources, vapors, flammable or explosive gas, or volatile objects spread in the air.
- (2) The place with high-frequency devices (such as welding machine, medical equipment).
- (3) The place near coast area.
- (4) The place with oil or fumes in the air.
- (5) The place with sulfured gas.
- (6) Other places with special circumstances.
- (7) The appliance shall not be installed in the laundry.
- (8) It's not allowed to be installed on the unstable or motive base structure(such as truck) or in the corrosive environment (such as chemical factory).

### 2. Indoor Unit:

- (1) There should be no obstruction near air inlet and air outlet.
- (2) Select a location where the condensation water can be dispersed easily and won't affect other people.
- (3) Select a location which is convenient to connect the outdoor unit and near the power socket.
- (4) Select a location which is out of reach for children.
- (5) The location should be able to withstand the weight of indoor unit and won't increase noise and vibration.
- (6) The appliance must be installed 2.5m above floor.
- (7) Don't install the indoor unit right above the electric appliance.
- (8) Please try your best to keep way from fluorescent lamp.

### 3. Outdoor Unit:

- (1) Select a location where the noise and outflow air emitted by the outdoor unit will not affect neighborhood.
- (2) The location should be well ventilated and dry, in which the outdoor unit won't be exposed directly to sunlight or strong wind.

(3) The location should be able to withstand the weight of outdoor unit.

(4) Make sure that the installation follows the requirement of installation dimension diagram.

(5) Select a location which is out of reach for children and far away from animals or plants.If it is unavoidable, please add fence for safety purpose.

## 8.4 Electric Connection Requirement

### 1. Safety Precaution

(1) Must follow the electric safety regulations when installing the unit.

(2) According to the local safety regulations, use qualified power supply circuit and air switch.

(3) Make sure the power supply matches with the requirement of air conditioner. Unstable power supply or incorrect wiring may result in electric shock,fire hazard or malfunction. Please install proper power supply cables before using the air conditioner.

(4) Properly connect the live wire, neutral wire and grounding wire of power socket.

(5) Be sure to cut off the power supply before proceeding any work related to electricity and safety.

(6) Do not put through the power before finishing installation.

(7) If the supply cord is damaged, it must be replaced by the manufacturer, its service agent or similarly qualified persons in order to avoid a hazard .

(8) The temperature of refrigerant circuit will be high, please keep the interconnection cable away from the copper tube.

(9) The appliance shall be installed in accordance with national wiring regulations.

(10) Appliance shall be installed, operated and stored in a room with a floor area larger than  $Xm^2$ (Please refer to table "a" in section of " Safety Operation of Inflammable Refrigerant" for Space X.)



Please notice that the unit is filled with flammable gas R32. Inappropriate treatment of the unit involves the risk of severe damages of people and material. Details to this refrigerant are found in chapter "refrigerant".

### 2. Grounding Requirement:

(1) The air conditioner is the first class electric appliance.It must be properly grounding with specialized grounding device by a professional.

Please make sure it is always grounded effectively,otherwise it may cause electric shock.

(2) The yellow-green wire in air conditioner is grounding wire, which can't be used for other purposes.

(3) The grounding resistance should comply with national electric safety regulations.

(4) The appliance must be positioned so that the plug is accessible.

(5) An all-pole disconnection switch having a contact separation of at least 3mm in all poles should be connected in fixed wiring.

(6) Including an air switch with suitable capacity, please note the following table. Air switch should be included magnet buckle and heating buckle function, it can protect the circuit-short and overload. (Caution: please do not use the fuse only for protect the circuit)

Model	Air switch capacity	Power cord
09/12K	10A	3G1.0
18K	16A	3G1.5
24K	25A	3G2.5

## 8.5 Installation of Indoor Unit

### 1. Choosing Installation location

Recommend the installation location to the client and then confirm it with the client.

### 2. Install Wall-mounting Frame

(1) Hang the wall-mounting frame on the wall; adjust it in horizontal position with the level meter and then point out the screw fixing holes on the wall.

(2) Drill the screw fixing holes on the wall with impact drill (the specification of drill head should be the same as the plastic expansion particle) and then fill the plastic expansion particles in the holes.

(3) Fix the wall-mounting frame on the wall with tapping screws and then check if the frame is firmly installed by pulling the frame. If the plastic expansion particle is loose, please drill another fixing hole nearby.

### 3. Drill Piping Hole

(1) Choose the position of piping hole according to the direction of outlet pipe. The position of piping hole should be a little lower than the wall-mounted frame, shown as below. (As show in Fig.1)

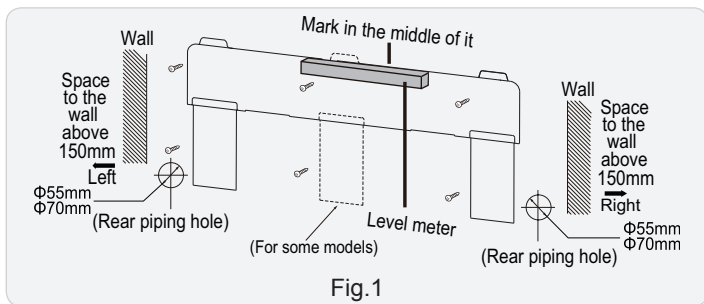

(2) Drill a piping hole with the diameter of  $\Phi 55\text{mm}$  or  $\Phi 70\text{mm}$  on the selected outlet pipe position. In order to drain smoothly, slant the piping hole on the wall slightly downward to the outdoor side with the gradient of  $5-10^\circ$ . (As show in Fig.2)

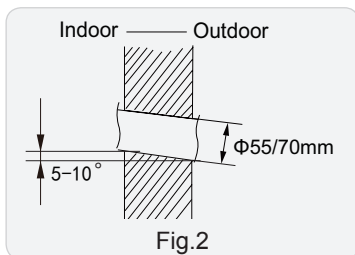

### ⚠ Note:

Pay attention to dust prevention and take relevant safety measures when drilling the hole.

### 4. Outlet Pipe

(1) The pipe can be led out in the direction of right, rear right, left or rear left. (As show in Fig.3)

(2) When selecting leading out the pipe from left or right, please cut off the corresponding hole on the bottom case. (As show in Fig.4)

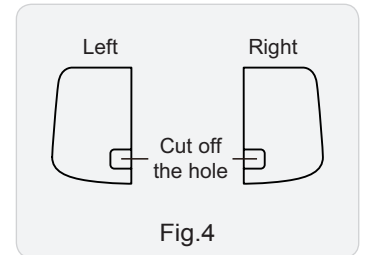
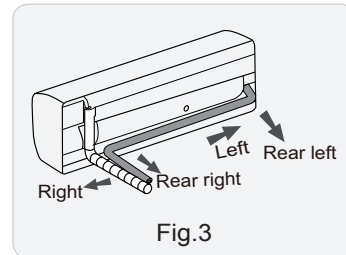

### 5. Connect the Pipe of Indoor Unit

(1) Aim the pipe joint at the corresponding bellmouth. (As show in Fig.5)

(2) Pretightening the union nut with hand.

(3) Adjust the torque force by referring to the following sheet. Place the open-end wrench on the pipe joint and place the torque wrench on the union nut. Tighten the union nut with torque wrench. (As show in Fig.6)

(4) Wrap the indoor pipe and joint of connection pipe with insulating pipe, and then wrap it with tape. (As show in Fig.7)

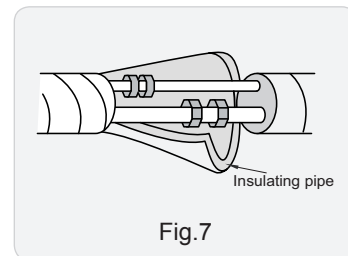
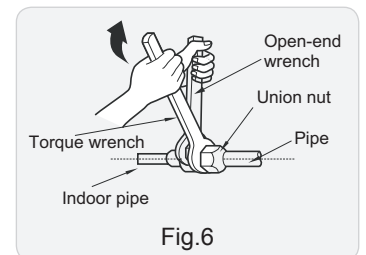
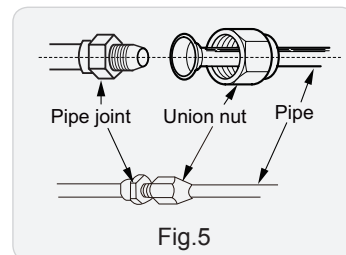

Refer to the following table for wrench moment of force:

Piping size	Tightening torque(N·m)
1/4"	15~20
3/8"	30~40
1/2"	45~55
5/8"	60~65
3/4"	70~75

## 6. Install Drain Hose

(1) Connect the drain hose to the outlet pipe of indoor unit.(As show in Fig.8)

(2) Bind the joint with tape.(As show in Fig.9)

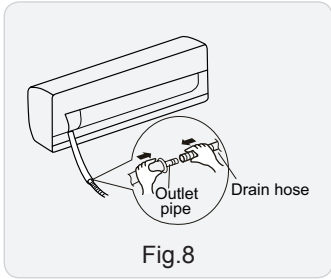

Fig.8

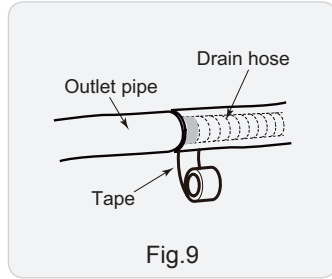

Fig.9

### ⚠ Note:

(1) Add insulating pipe in the indoor drain hose in order to prevent condensation.

(2) The plastic expansion particles are not provided.

(As show in Fig.10)

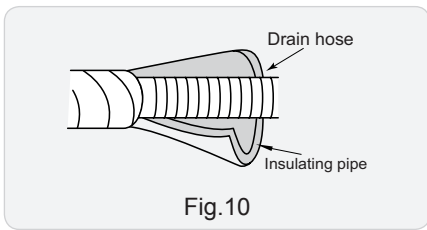

Fig.10

## 7. Connect Wire of Indoor Unit

(1) Open the panel, remove the screw on the wiring cover and then take down the cover.(As show in Fig.11)

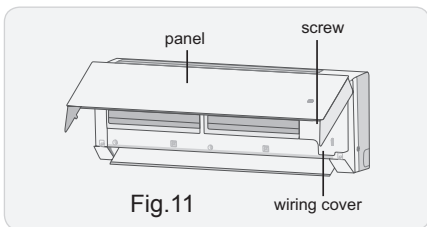

Fig.11

(2) Make the power connection wire go through the cable-cross hole at the back of indoor unit and then pull it out from the front side.(As show in Fig.12)

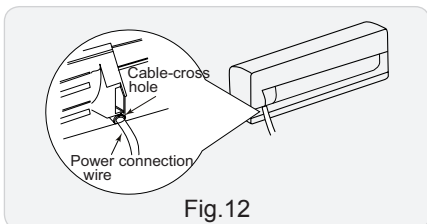

Fig.12

(3) Remove the wire clip; connect the power connection wiresignal control wire (only for cooling and heating unit) to the wiring terminal according to the color; tighten the screw and then fix the power connection wire with wire clip.(As show in Fig.13)

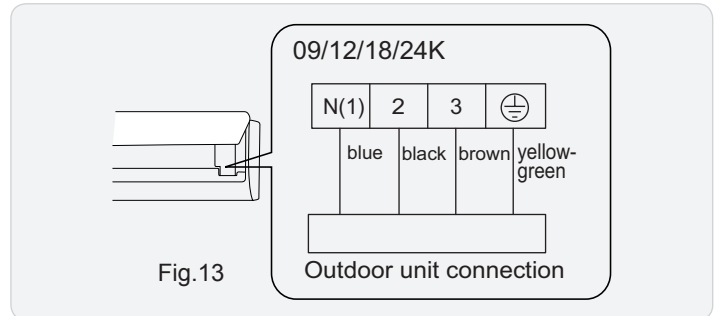

Fig.13

Note: The wiring connect is for reference only, please refer to the actual one.

(4) Put wiring cover back and then tighten the screw.

(5) Close the panel.

### ⚠ Note:

(1) All wires of indoor unit and outdoor unit should be connected by a professional.

(2) If the length of power connection wire is insufficient, please contact the supplier for a new one. Avoid extending the wire by yourself.

(3) For the air conditioner with plug, the plug should be reachable after finishing installation.

(4) For the air conditioner without plug, an air switch must be installed in the line. The air switch should be all-pole parting and the contact parting distance should be more than 3mm.

## 8. Bind up Pipe

(1) Bind up the connection pipe, power cord and drain hose with the band.(As show in Fig.14)

(2) Reserve a certain length of drain hose and power cord for installation when binding them. When binding to a certain degree, separate the indoor power and then separate the drain hose.(As show in Fig.15)

(3) Bind them evenly.

(4) The liquid pipe and gas pipe should be bound separately at the end.

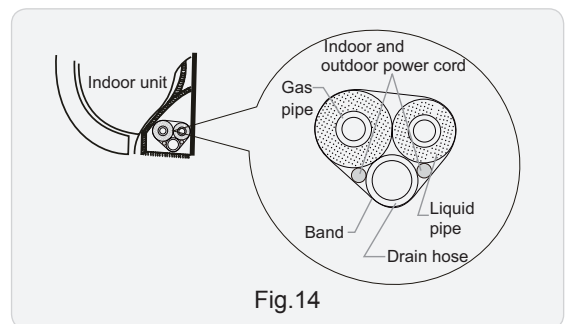

Fig.14

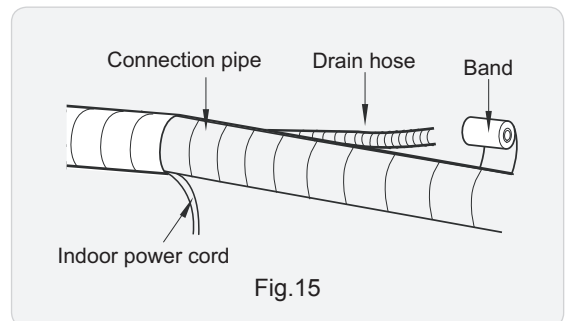

Fig.15

**⚠ Note:**

- (1) The power cord and control wire can't be crossed or winding.
- (2) The drain hose should be bound at the bottom.

**9. Hang the Indoor Unit**

- (1) Put the bound pipes in the wall pipe and then make them pass through the wall hole.
- (2) Hang the indoor unit on the wall-mounting frame.
- (3) Stuff the gap between pipes and wall hole with sealing gum.
- (4) Fix the wall pipe.(As show in Fig.16)
- (5) Check if the indoor unit is installed firmly and closed to the wall.(As show in Fig.17)

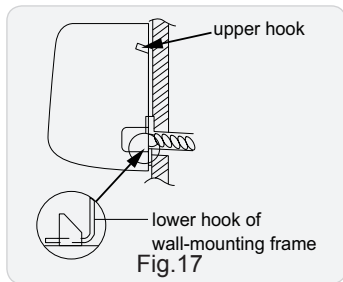
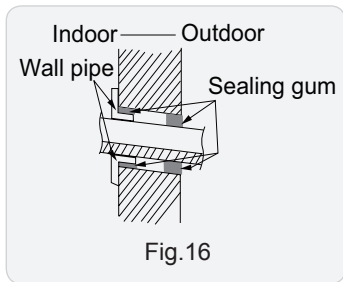

**⚠ Note:**

Do not bend the drain hose too excessively in order to prevent blocking.

**8.6 Installation of Outdoor Unit**

**1. Fix the Support of Outdoor Unit(Select it according to the actual installation situation)**

- (1) Select installation location according to the house structure.
- (2) Fix the support of outdoor unit on the selected location with expansion screws.

**⚠ Note:**

- (1) Take sufficient protective measures when installing the outdoor unit.
- (2) Make sure the support can withstand at least four times the unit weight.
- (3) The outdoor unit should be installed at least 3cm above the floor in order to install drain joint.(As show in Fig.18)
- (4) For the unit with cooling capacity of 2300W~5000W, 6 expansion screws are needed; for the unit with cooling capacity of 6000W~8000W, 8 expansion screws are needed; for the unit with cooling capacity of 10000W~16000W, 10 expansion screws are needed.

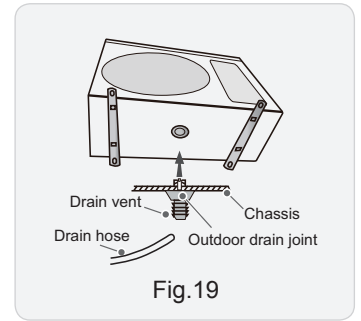
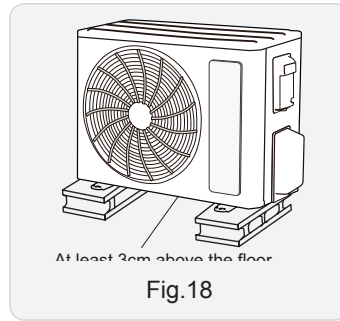

**2. Install Drain Joint(Only for cooling and heating unit)**

- (1) Connect the outdoor drain joint into the hole on the chassis.
  - (2) Connect the drain hose into the drain vent.
- (As show in Fig.19)

**3. Fix Outdoor Unit**

- (1) Place the outdoor unit on the support.
  - (2) Fix the foot holes of outdoor unit with bolts.
- (As show in Fig.20)

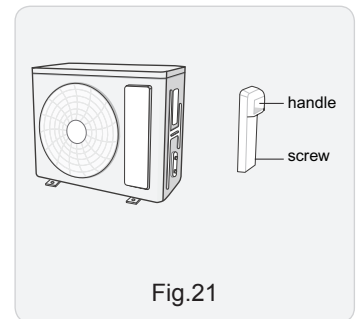
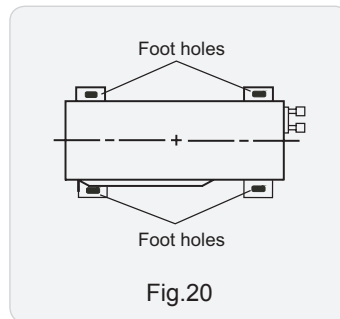

**4. Connect Indoor and Outdoor Pipes**

- (1) Remove the screw on the right handle of outdoor unit and then remove the handle.(As show in Fig.21)
- (2) Remove the screw cap of valve and aim the pipe joint at the bellmouth of pipe.(As show in Fig.22)

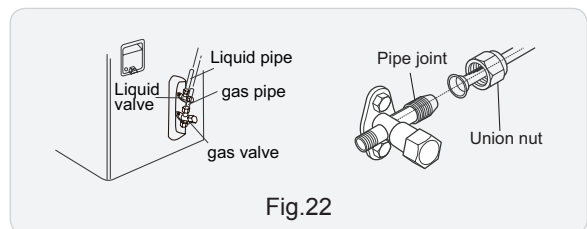

- (3) Pretightening the union nut with hand.
- (4) Tighten the union nut with torque wrench .

Refer to the following table for wrench moment of force:

Piping size	Tightening torque(N·m)
1/4"	15~20
3/8"	30~40
1/2"	45~55
5/8"	60~65
3/4"	70~75

## 5. Connect Outdoor Electric Wire

(1) Remove the wire clip; connect the power connection wire and signal control wire (only for cooling and heating unit) to the wiring terminal according to the color; fix them with screws.(As show in Fig.23)

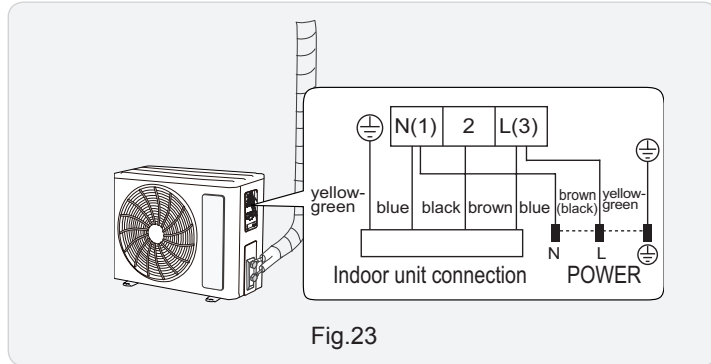

Fig.23

Note: the wiring connect is for reference only, please refer to the actual one.

(2) Fix the power connection wire and signal control wire with wire clip (only for cooling and heating unit).

### ⚠ Note:

- (1) After tightening the screw, pull the power cord slightly to check if it is firm.
- (2) Never cut the power connection wire to prolong or shorten the distance.

## 6. Neaten the Pipes

- (1) The pipes should be placed along the wall, bent reasonably and hidden possibly. Min. semidiameter of bending the pipe is 10cm.
- (2) If the outdoor unit is higher than the wall hole, you must set a U-shaped curve in the pipe before pipe goes into the room, in order to prevent rain from getting into the room.(As show in Fig.24)

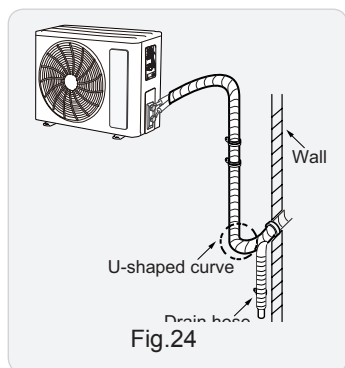

Fig.24

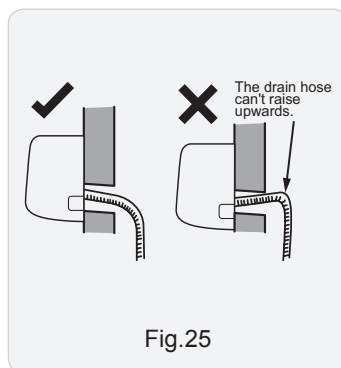

Fig.25

### ⚠ Note:

- (1) The through-wall height of drain hose shouldnt be higher than the outlet pipe hole of indoor unit.(As show in Fig.25)
- (2) Slant the drain hose slightly downwards. The drain hose can't be curved, raised and fluctuant, etc.(As show in Fig.26)
- (3) The water outlet can't be placed in water in order to drain smoothly.(As show in Fig.27)

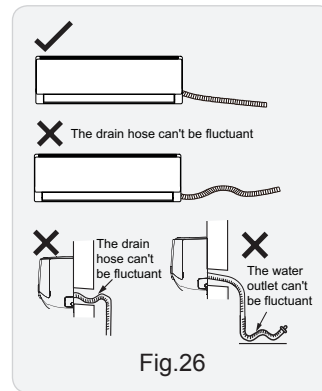

Fig.26

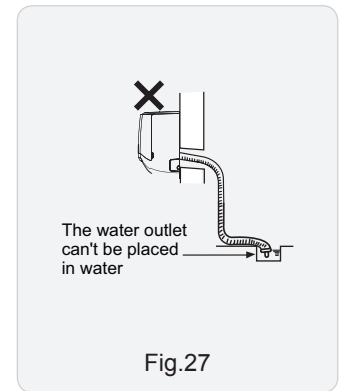

Fig.27

## 8.7 Vacuum Pumping and Leak Detection

### 1. Use Vacuum Pump

- (1) Remove the valve caps on the liquid valve and gas valve and the nut of refrigerant charging vent.
- (2) Connect the charging hose of piezometer to the refrigerant charging vent of gas valve and then connect the other charging hose to the vacuum pump.
- (3) Open the piezometer completely and operate for 10-15min to check if the pressure of piezometer remains in  $-0.1\text{MPa}$ .
- (4) Close the vacuum pump and maintain this status for 1-2min to check if the pressure of piezometer remains in  $-0.1\text{MPa}$ . If the pressure decreases, there may be leakage.
- (5) Remove the piezometer, open the valve core of liquid valve and gas valve completely with inner hexagon spanner.
- (6) Tighten the screw caps of valves and refrigerant charging vent.(As show in Fig.28)
- (7) Reinstall the handle.

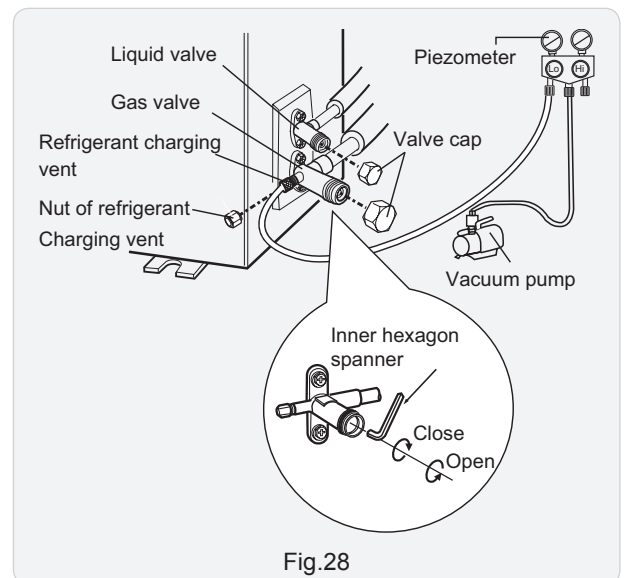

Fig.28

### 2. Leakage Detection

- (1) With leakage detector: Check if there is leakage with leakage detector.
- (2) With soap water: If leakage detector is not available, please use soap water for leakage detection. Apply soap water at the suspected position and keep the soap water for more than 3min. If there are air bubbles coming out of this position, there's a leakage.

## 8.8 Check after Installation and Test Operation

### 1. Check after Installation

Check according to the following requirement after finishing installation.

NO.	Items to be checked	Possible malfunction
1	Has the unit been installed firmly?	The unit may drop, shake or emit noise.
2	Have you done the refrigerant leakage test?	It may cause insufficient cooling (heating) capacity.
3	Is heat insulation of pipeline sufficient?	It may cause condensation and water dripping.
4	Is water drained well?	It may cause condensation and water dripping.
5	Is the voltage of power supply according to the voltage marked on the nameplate?	It may cause malfunction or damage the parts.
6	Is electric wiring and pipeline installed correctly?	It may cause malfunction or damage the parts.
7	Is the unit grounded securely?	It may cause electric leakage.
8	Does the power cord follow the specification?	It may cause malfunction or damage the parts.
9	Is there any obstruction in air inlet and air outlet?	It may cause insufficient cooling (heating) capacity.
10	The dust and sundries caused during installation are removed?	It may cause malfunction or damaging the parts.
11	The gas valve and liquid valve of connection pipe are open completely?	It may cause insufficient cooling (heating) capacity.
12	Is the inlet and outlet of piping hole been covered?	It may cause insufficient cooling(heating) capacity or waster eletricity.

### 2. Test Operation

(1) Preparation of test operation

- The client approves the air conditioner installation.
- Specify the important notes for air conditioner to the client.

(2) Method of test operation

- Put through the power, press ON/OFF button on the remote controller to start operation.
- Press MODE button to select AUTO, COOL, DRY, FAN and HEAT to check whether the operation is normal or not.
- If the ambient temperature is lower than 16°C, the air conditioner can't start cooling.

# 9. Maintenance

## 9.1 Error Code List

Malfunction Name	Display Method of Indoor Unit (Error Code)	A/C Status	Possible Causes(For specific maintenance method, please refer to the following procedure of troubleshooting)
High pressure protection of system	E1	Cool/Dry: except indoor fan operates, all loads stop operation. Heat: all loads stops operation.	1. Refrigerant was superabundant; 2. Poor heat exchange (including filth blockage of heat exchanger and bad radiating environment ); Ambient temperature is too high.
Anti-freezing protection for evaporator	E2	Cool/Dry: compressor and outdoor fan stop while indoor fan operates.	Not the error code. It's the status code for the operation.
System block or refrigerant leakage	E3	The Dual-8 Code Display will show E3 until the low pressure switch stop operation.	1.Low-pressure protection 2.Low-pressure protection of system 3.Low-pressure protection of compressor
High discharge temperature protection of compressor	E4	Cool/Dry: compressor and outdoor fan stop while indoor fan operates. Heat: all loads stop.	Please refer to the malfunction analysis (discharge protection, overload).
Overcurrent protection	E5	Cool/Dry:compressor and outdoor fan stop while indoor fan operates. Heat: all loads stop.	1. Supply voltage is unstable; 2. Supply voltage is too low and load is too high; 3. Evaporator is dirty.
Communication Malfunction	E6	Cool:compressor stops while indoor fan motor operates. Heat: all loads stops operation.	Refer to the corresponding malfunction analysis.
High temperature resistant protection	E8	Cool: compressor will stop while indoor fan will operate. Heat: all loads stops operation.	Refer to the malfunction analysis (overload, high temperature resistant).
EEPROM malfunction	EE	Cool/Dry:compressor will stop while indoor fan will operate; Heat: all loads stops operation.	Replace outdoor control panel AP1
Limit/decrease frequency due to high temperature of module	EU	All loads operate normally, while operation frequency for compressor is decreased	Discharging after the complete unit is de-energized for 20mins, check whether the thermal grease on IPM Module of outdoor control panel AP1 is sufficient and whether the radiator is inserted tightly. If it's no use, please replace control panel AP1.
Malfunction protection of jumper cap	C5	Wireless remote receiver and button are effective, but can not dispose the related command	1. No jumper cap insert on mainboard. 2. Incorrect insert of jumper cap. 3. Jumper cap damaged. 4. Abnormal detecting circuit of mainboard.
Refrigerant insufficient protection	F0	Cool/Dry:compressor and outdoor fan will stop while indoor fan will operate; Heat: all loads stops operation.	1. Is system cooling under high humidity environment, thus temperature difference of heat transfer is small; 2. Check whether the big valve and small valve of outdoor unit are opened completely; 3. Is the temperature sensor of evaporator of indoor unit loose? 4. Is the temperature sensor of condenser of outdoor unit loose? 5. Is the capillary or the electronic expansion valve blocked? 6. Is refrigerant leaking?
Indoor ambient temperature sensor is open/short circuited	F1	Cool/Dry:indoor unit operates while other loads will stop; Heat: all loads stops operation.	1. Loosening or bad contact of indoor ambient temp. sensor and mainboard terminal. 2. Components in mainboard fell down leads short circuit. 3. Indoor ambient temp. sensor damaged.(check with sensor resistance value chart) 4. Mainboard damaged.

Indoor evaporator temperature sensor is open/short circuited	F2	AC stops operation once reaches the setting temperature. Cooling, drying: internal fan motor stops operation while other loads stop operation; heating: AC stop operation	1. Loosening or bad contact of Indoor evaporator temp. sensor and mainboard terminal. 2. Components on the mainboard fall down leads short circuit. 3. Indoor evaporator temp. sensor damaged.(check temp. sensor value chart for testing) 4. Mainboard damaged.
Outdoor ambient temperature sensor is open/short circuited	F3	Cool/Dry: compressor stops while indoor fan operates; Heat: all loads stops operation.	Outdoor temperature sensor hasn't been connected well or is damaged. Please check it by referring to the resistance table for temperature sensor)
Outdoor condenser temperature sensor is open/short circuited	F4	Cool/Dry: compressor stops while indoor fan will operate; Heat: all loads stops operation.	Outdoor temperature sensor hasn't been connected well or is damaged. Please check it by referring to the resistance table for temperature sensor)
Outdoor discharge temperature sensor is open/short circuited	F5	Cool/Dry: compressor will stop after operating for about 3 mins, while indoor fan will operate; Heat: the complete unit will stop after operating for about 3 mins.	1.Outdoor temperature sensor hasn't been connected well or is damaged. Please check it by referring to the resistance table for temperature sensor) 2.The head of temperature sensor hasn't been inserted into the copper tube
Limit/decrease frequency due to overload	F6	All loads operate normally, while operation frequency for compressor is decreased	Refer to the malfunction analysis (overload, high temperature resistant)
Decrease frequency due to overcurrent	F8	All loads operate normally, while operation frequency for compressor is decreased	The input supply voltage is too low; System pressure is too high and overload
Decrease frequency due to high air discharge	F9	All loads operate normally, while operation frequency for compressor is decreased	Overload or temperature is too high; Refrigerant is insufficient; Malfunction of electric expansion valve (EKV)
Limit/decrease frequency due to antifreezing	FH	All loads operate normally, while operation frequency for compressor is decreased	Poor air-return in indoor unit or fan speed is too low
Voltage for DC bus-bar is too high	PH	Cool/Dry: compressor will stop while indoor fan will operate; Heat: all loads stops operation.	1. Measure the voltage of position L and N on wiring board (XT), if the voltage is higher than 265VAC, turn on the unit after the supply voltage is increased to the normal range. 2.If the AC input is normal, measure the voltage of electrolytic capacitor C on control panel (AP1), if it's normal, theres malfunction for the circuit, please replace the control panel (AP1)
Voltage of DC bus-bar is too low	PL	Cool/Dry: compressor will stop while indoor fan will operate; Heat: all loads stops operation.	1. Measure the voltage of position L and N on wiring board (XT), if the voltage is higher than 150VAC, turn on the unit after the supply voltage is increased to the normal range. 2.If the AC input is normal, measure the voltage of electrolytic capacitor C on control panel (AP1), if it's normal, theres malfunction for the circuit, please replace the control panel (AP1)
Compressor Min frequency in test state	P0		Showing during min. cooling or min. heating test
Compressor rated frequency in test state	P1		Showing during nominal cooling or nominal heating test
Compressor maximum frequency in test state	P2		Showing during max. cooling or max. heating test
Compressor intermediate frequency in test state	P3		Showing during middle cooling or middle heating test
Overcurrent protection of phase current for compressor	P5	Cool/Dry: compressor will stop while indoor fan will operate; Heat: all loads stops operation.	Refer to the malfunction analysis (IPM protection, loss of synchronism protection and overcurrent protection of phase current for compressor.
Charging malfunction of capacitor	PU	Cool/Dry: compressor will stop while indoor fan will operate; Heat: all loads stops operation.	Refer to the part three—charging malfunction analysis of capacitor



Malfunction of module temperature sensor circuit	P7	Cool/Dry: compressor will stop while indoor fan will operate; Heat: all loads stops operation.	Replace outdoor control panel AP1
Module high temperature protection	P8	Cool:compressor will stop while indoor fan will operate; Heat: all loads stops operation.	After the complete unit is de-energized for 20mins, check whether the thermal grease on IPM Module of outdoor control panel AP1 is sufficient and whether the radiator is inserted tightly. If it's no use, please replace control panel AP1.
Overload protection for compressor	H3	Cool/Dry: compressor will stop while indoor fan will operate; Heat: all loads stops operation.	1. Wiring terminal OVC-COMP is loosened. In normal state, the resistance for this terminal should be less than 1ohm. 2.Refer to the malfunction analysis ( discharge protection, overload)
IPM protection	H5	Cool/Dry: compressor will stop while indoor fan will operate; Heat: all loads stops operation.	Refer to the malfunction analysis (IPM protection, loss of synchronism protection and overcurrent protection of phase current for compressor.
Malfunction of zero-cross detection circuit	U8	All loads stops operation.	1.Power supply is abnormal; 2.Detection circuit of indoor control mainboard is abnormal.
Internal motor (fan motor) do not operate	H6	Internal fan motor, external fan motor, compressor and electric heater stop operation,guide louver stops at present location.	1. Bad contact of DC motor feedback terminal. 2. Bad contact of DC motor control end. 3. Fan motor is stalling. 4. Motor malfunction. 5. Malfunction of mainboard revdetecting circuit.
Desynchro-nizing of compressor	H7	Cool/Dry: compressor will stop while indoor fan will operate; Heat: all loads stops operation.	Refer to the malfunction analysis (IPM protection, loss of synchronism protection and overcurrent protection of phase current for compressor.
PFC protection	HC	Cool/Dry: compressor will stop while indoor fan will operate; Heat: all loads stops operation.	Refer to the malfunction analysis
Outdoor DC fan motor malfunction	L3	Outdoor DC fan motor malfunction lead to compressor stop operation,	DC fan motor malfunction or system blocked or the connector loosed
power protection	L9	compressor stop operation and Outdoor fan motor will stop 30s latter , 3 minutes latter fan motor and compressor will restart	To protect the electronical components when detect high power
Indoor unit and outdoor unit doesnt match	LP	compressor and Outdoor fan motor can't work	Indoor unit and outdoor unit doesnt match
Failure start-up	LC	Cool/Dry: compressor will stop while indoor fan will operate; Heat: all loads stops operation.	Refer to the malfunction analysis
Defrosting	Heating indicator off for 0.5s and then blinks for 10s	Defrosting will occur in heating mode. Compressor will operate while indoor fan will stop operation.	Not the error code. It's the status code for the operation
The four-way valve is abnormal	U7	If this malfunction occurs in heating mode, all loads stop	1.Supply voltage is lower than AC175V; 2.Wiring terminal 4V is loosened or broken; 3.4V is damaged, please replace 4V.
Malfunction of phase current detection circuit for compressor	U1	Cool/Dry: compressor will stop while indoor fan will operate; Heat: all loads stops operation.	Replace outdoor control panel AP1

Malfunction of voltage dropping for DC busbar	U3	Cool/Dry: compressor will stop while indoor fan will operate; Heat: all loads stops operation.	Supply voltage is unstable
Malfunction of complete units current detection	U5	Cool/Dry: the compressor will stop while indoor fan will operate; Heat: all loads stops operation.	Theres circuit malfunction on outdoor units control panel AP1, please replace the outdoor units control panel AP1.
Cold air prevention protection	E9		Not the error code. It's the status code for the operation.
Refrigerant recovery mode	Fo	Cool/Dry: compressor and outdoor fan stops operation, while indoor fan operates.	Refrigerant recovery. The maintenance personnel operate it when he is maintaining the unit.
Undefined outdoor unit error	oE	Cool: compressor and outdoor fan stops operation, while indoor fan operates; Heat: compressor, outdoor fan and indoor fan stop operation.	1. Outdoor ambient temperature exceeds the operation range of unit (eg: less than -20°C or more than 60°C for cooling; more than 30°C for heating); 2. Failure startup of compressor? 3. Are wires of compressor not connected tightly? 4. Is compressor damaged? 5. Is main board damaged?
Malfunction of detecting plate(WIFI )	JF	Loads operate normally, while the unit can't be normally controlled by APP.	1. Main board of indoor unit is damaged; 2. Detection board is damaged; 3. The connection between indoor unit and detection board is not good;

### Analysis or processing of some of the malfunction display:

#### 1. Compressor discharge protection

Possible causes: shortage of refrigerant; blockage of air filter; poor ventilation or air flow short pass for condenser; the system has noncondensing gas (such as air, water etc.); blockage of capillary assy (including filter); leakage inside four-way valve causes incorrect operation; malfunction of compressor; malfunction of protection relay; malfunction of discharge sensor; outdoor temperature too high.

Processing method: refer to the malfunction analysis in the above section.

#### 2. Low voltage overcurrent protection

Possible cause: Sudden drop of supply voltage.

#### 3. Communication malfunction

Processing method: Check if communication signal cable is connected reliably.

#### 4. Sensor open or short circuit

Processing method: Check whether sensor is normal, connected with the corresponding position on the controller and if damage of lead wire is found.

#### 5. Compressor over load protection

Possible causes: insufficient or too much refrigerant; blockage of capillary and increase of suction temp.; improper running of compressor, burning in or stuck of bearing, damage of discharge valve; malfunction of protector.

Processing method: adjust refrigerant amount; replace the capillary; replace the compressor; use universal meter to check if the contactor of compress or is fine when it is not overheated, if not replace the protector.

#### 6. System malfunction

i.e. overload protection. When tube temperature (Check the temperature of outdoor heat exchanger when cooling and check the temperature of indoor heat exchanger when heating) is too high, protection will be activated.

Possible causes: Outdoor temperature is too high when cooling; insufficient outdoor air circulation; refrigerant flow malfunction.

please refer to the malfunction analysis in the previous section for handling method .

#### 7. IPM module protection

Processing method: Once the module malfunction happens, if it persists for a long time and can not be selfcanceled, cut off the power and turn off the unit, and then re-energize the unit again after about 10 min. After repeating the procedure for several times, if the malfunction still exists, replace the module.

If malfunction occurs, corresponding code will display and the unit will resume normal until protection or malfunction disappears.

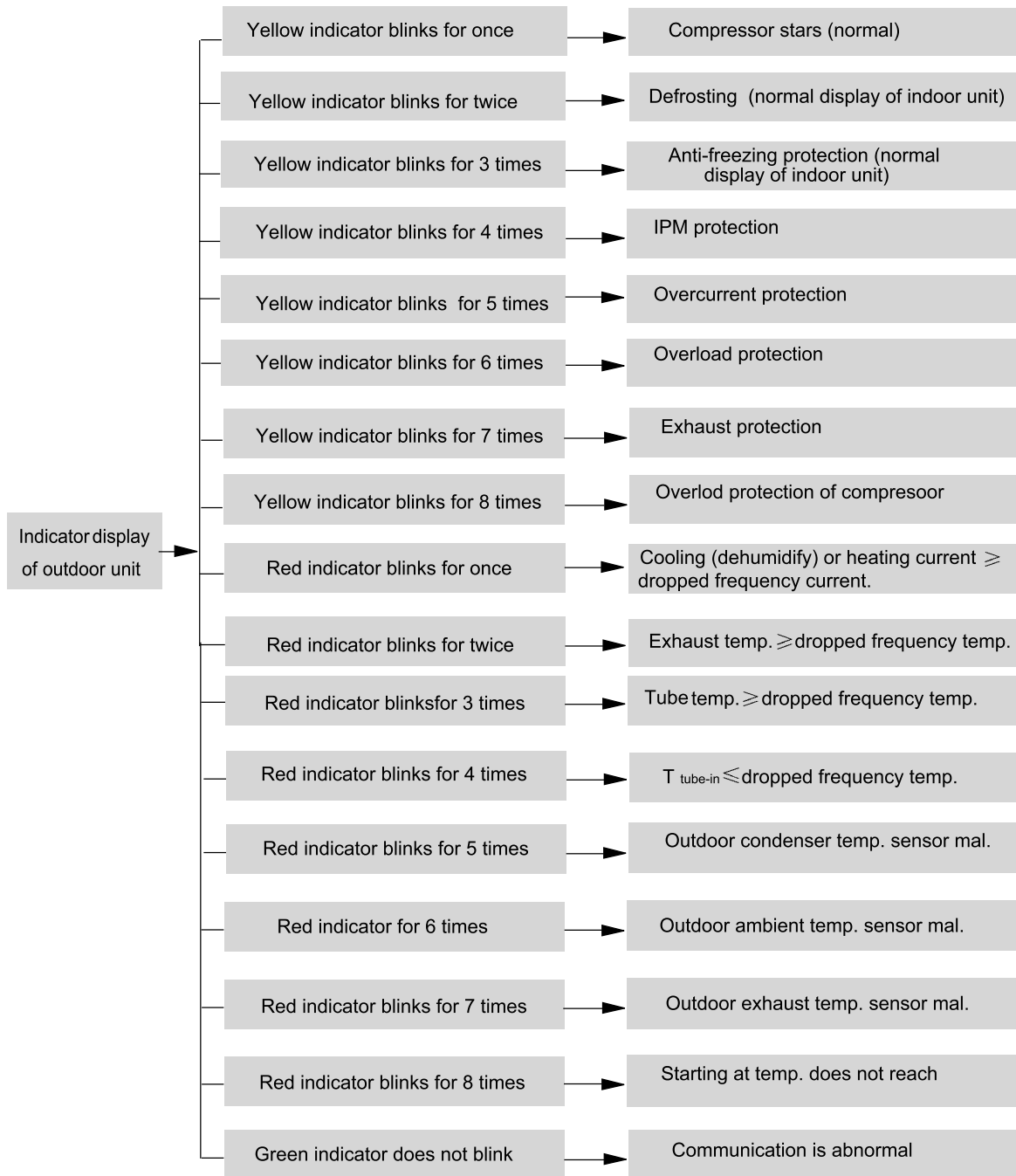

## 9.2 Procedure of Troubleshooting

### ●Indoor unit:

#### 1. Malfunction of Temperature Sensor F1, F2

Main detection points:

- Is the wiring terminal between the temperature sensor and the controller loosened or poorly contacted?
- Is there short circuit due to trip-over of the parts?
- Is the temperature sensor broken?
- Is mainboard broken?

Malfunction diagnosis process:

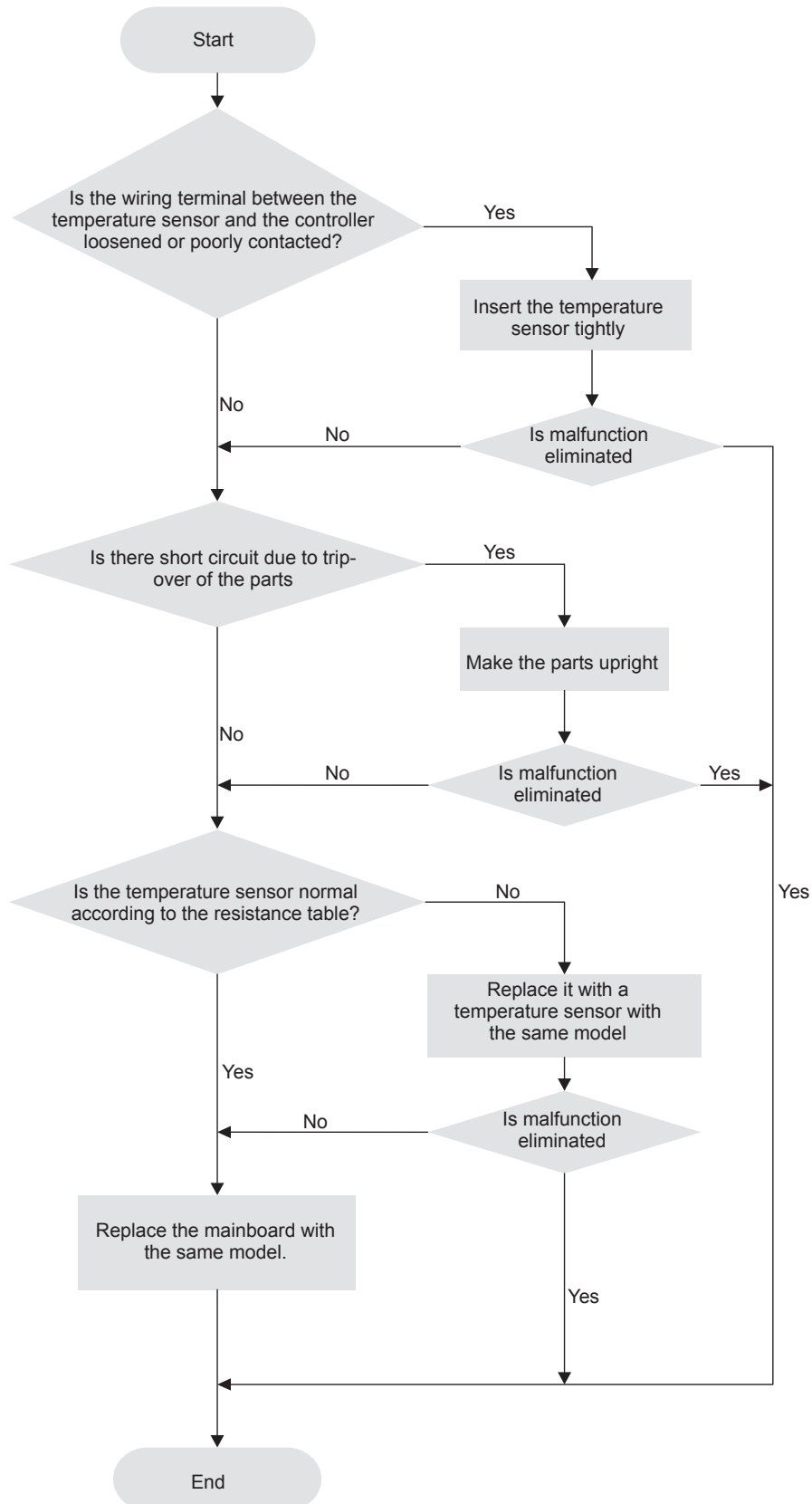

## 2. Malfunction of Blocked Protection of IDU Fan Motor H6

Main detection points:

- Smoothly is the terminal of motor connected tightly?
- The fan motor can't operate?
- The motor is broken?
- Detection circuit of the mainboard is defined abnormal?

Malfunction diagnosis process:

### 2.1 PG motor

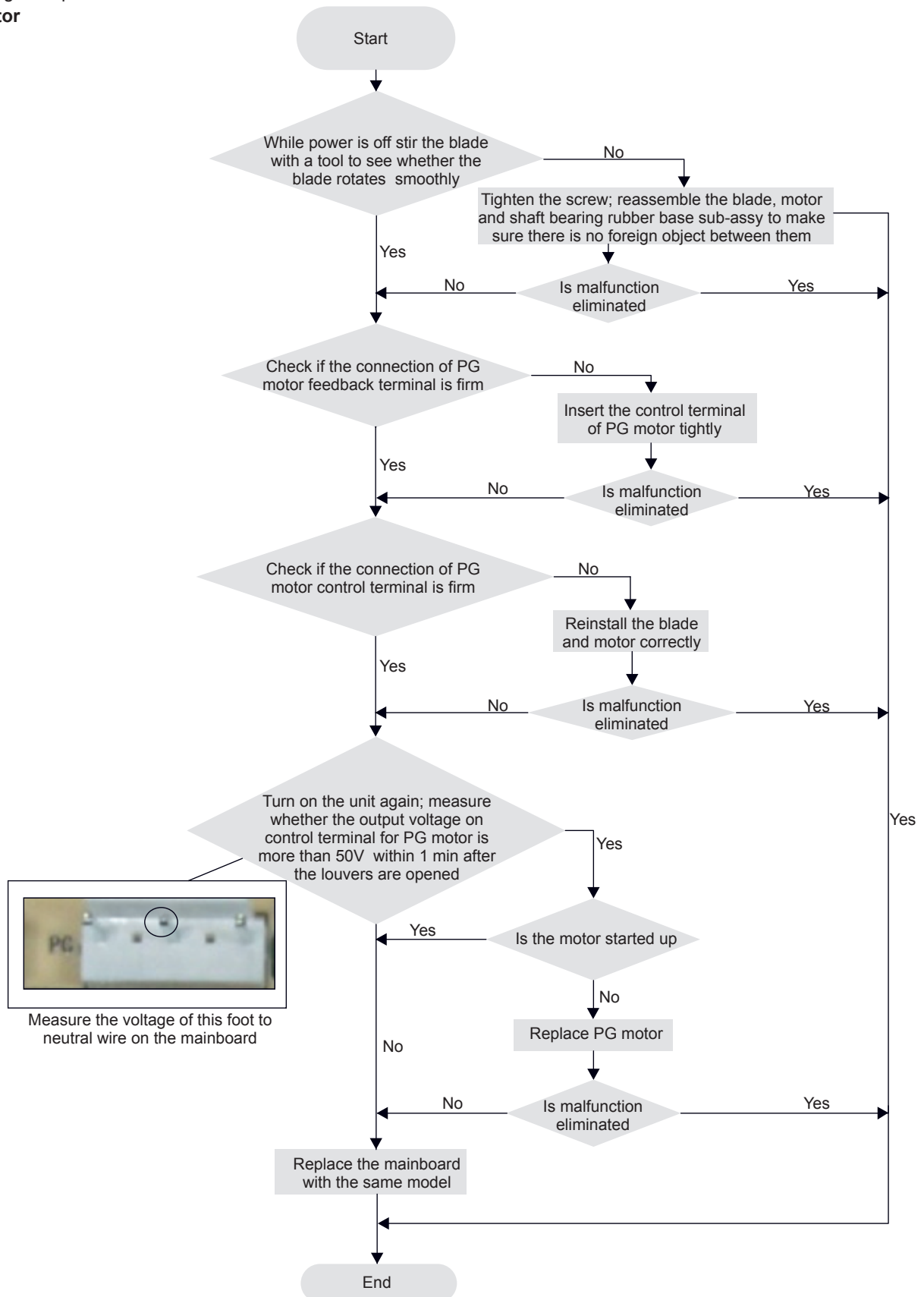

## 2.2 DC motor

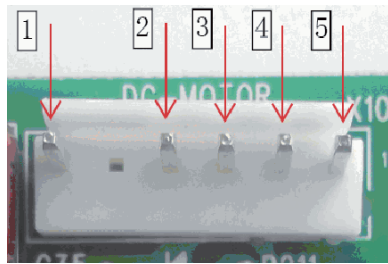
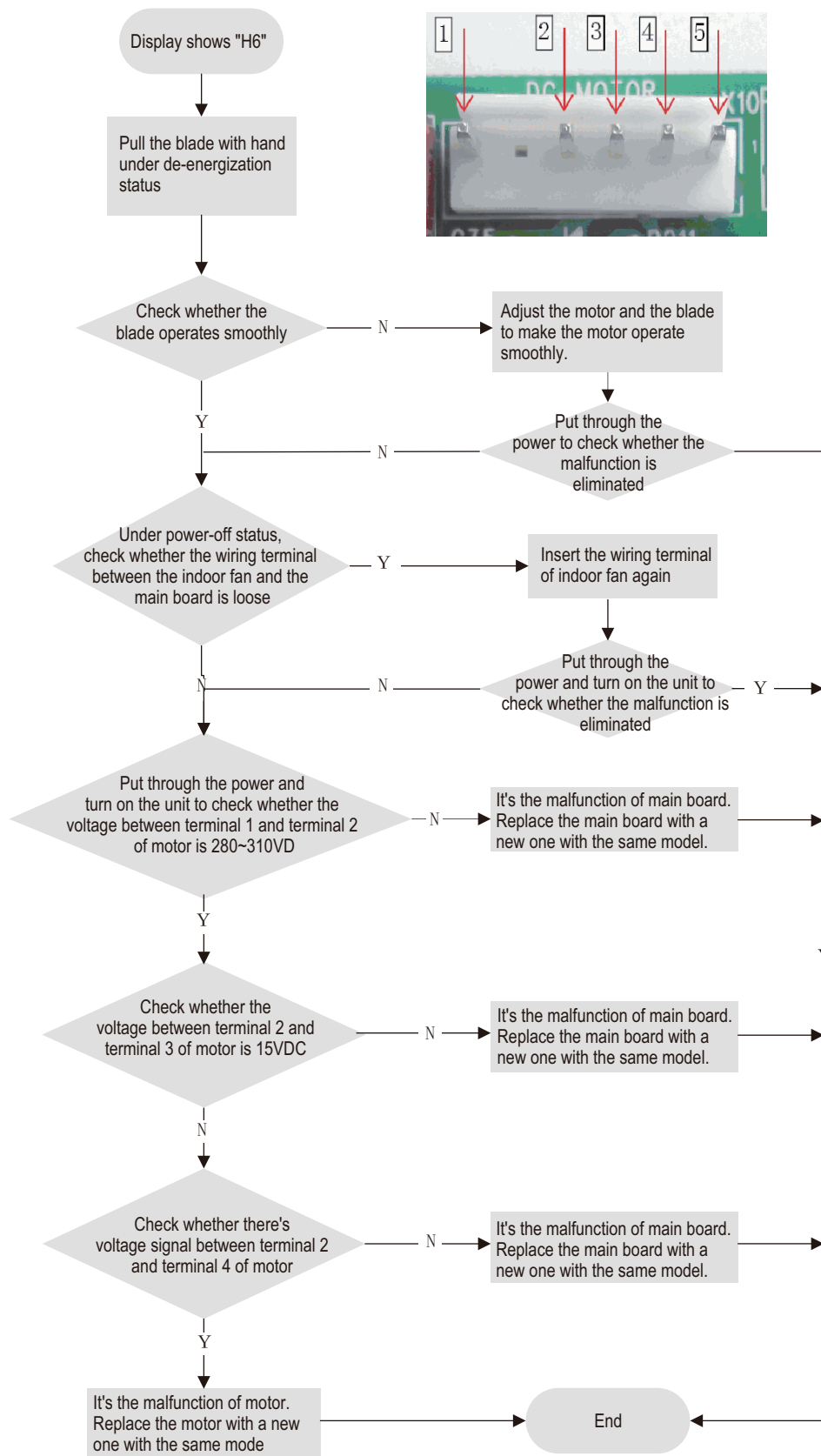

### 3. Malfunction of Protection of Jumper Cap C5

Main detection points:

- Is there jumper cap on the mainboard?
- Is the jumper cap inserted correctly and tightly?
- The jumper is broken?
- The motor is broken?
- Detection circuit of the mainboard is defined abnormal?

Malfunction diagnosis process:

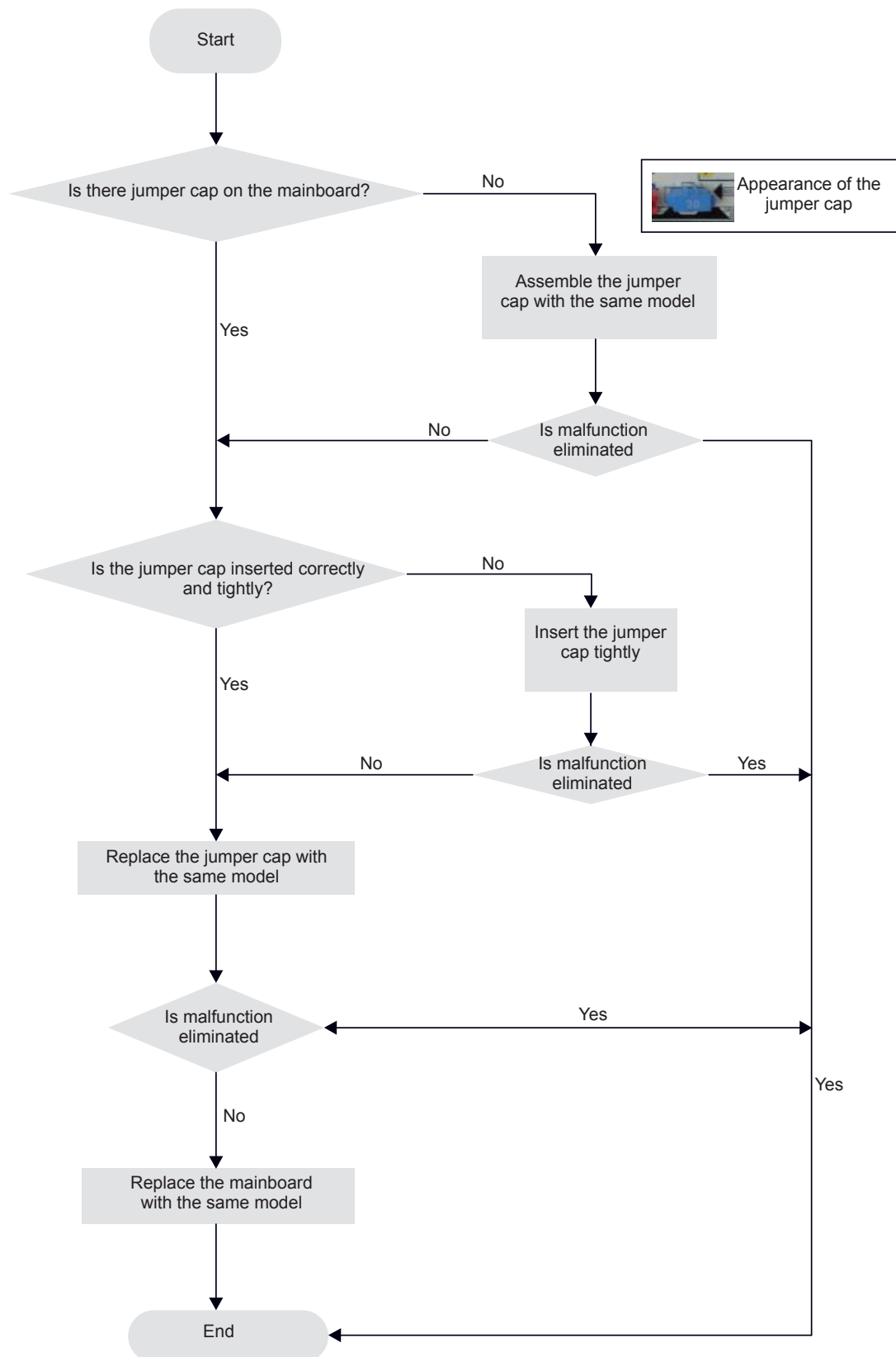

#### 4. Malfunction of Zero-crossing Inspection Circuit Malfunction of the IDU Fan Motor U8

Main detection points:

- Instant energization after de-energization while the capacitor discharges slowly?
- The zero-cross detection circuit of the mainboard is defined abnormal?

Malfunction diagnosis process:

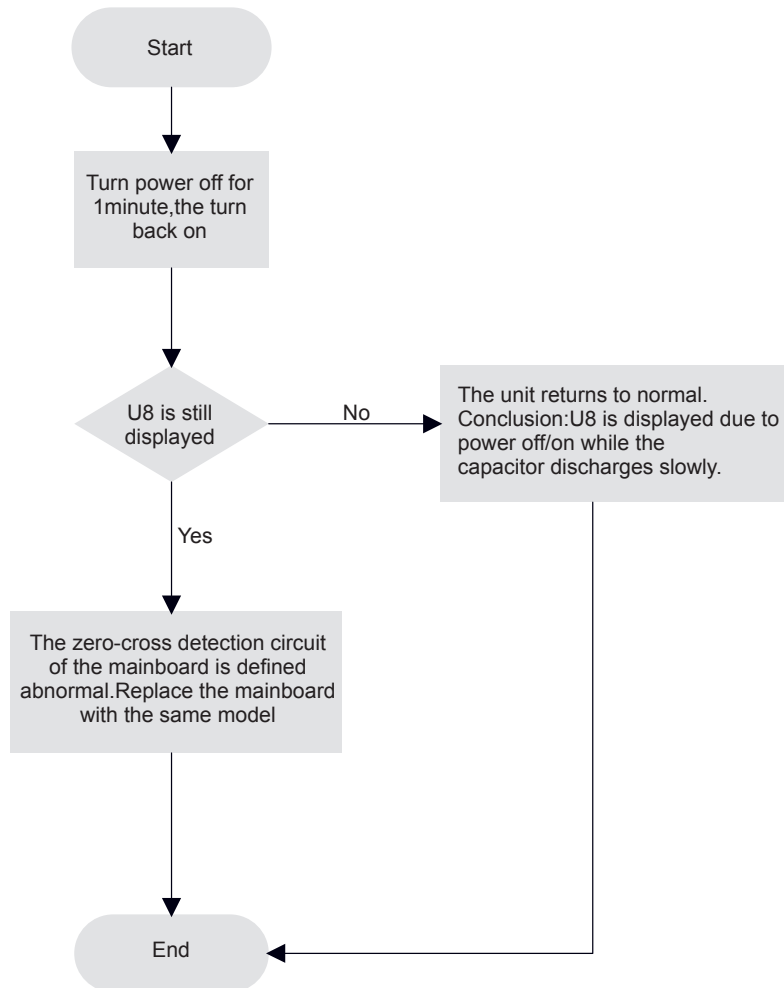



## 5. High Temperature and Overload Protection (AP1 below means control board of outdoor unit) E8

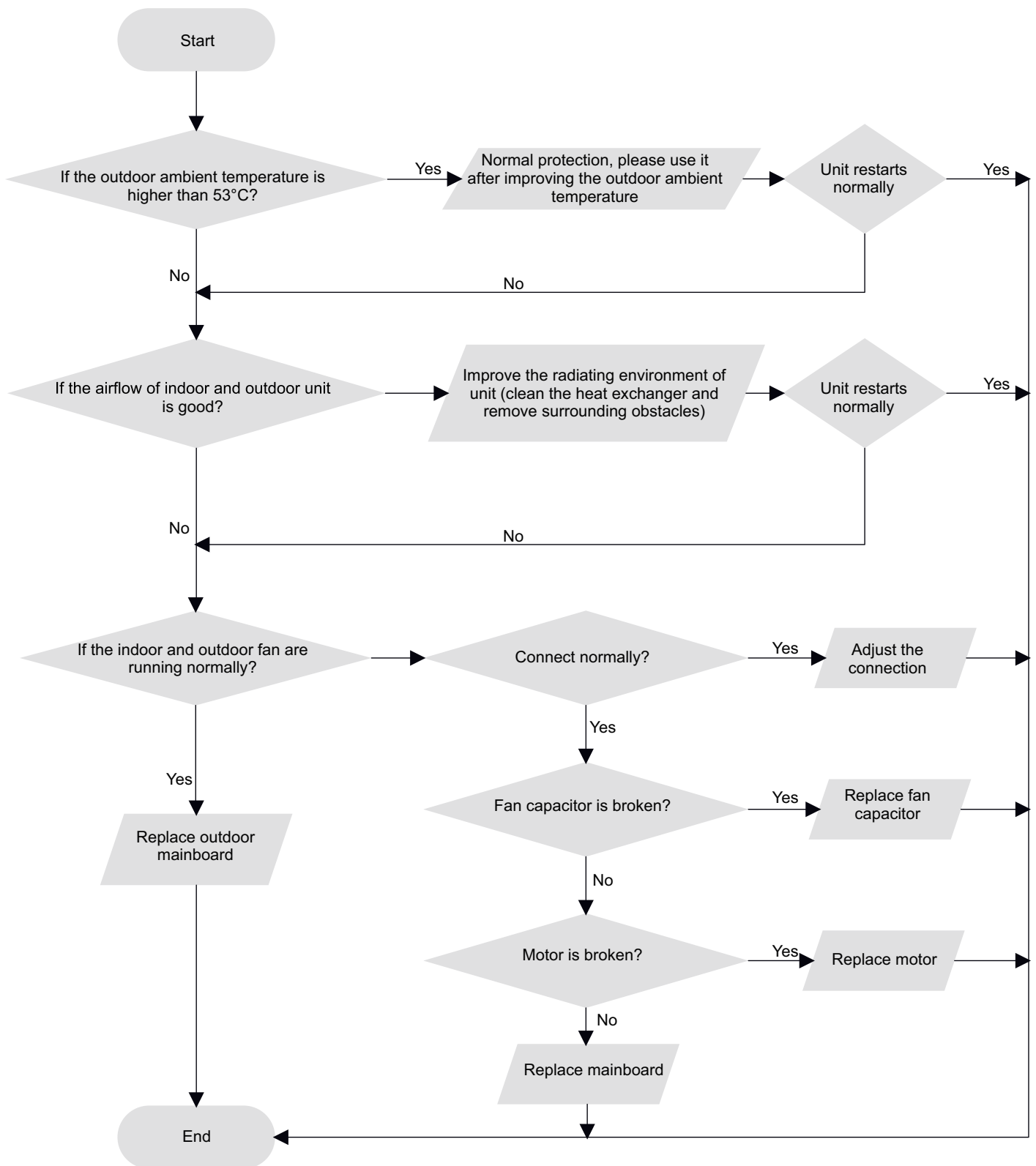

## 6. Malfunction of detecting plate(WIFI) JF

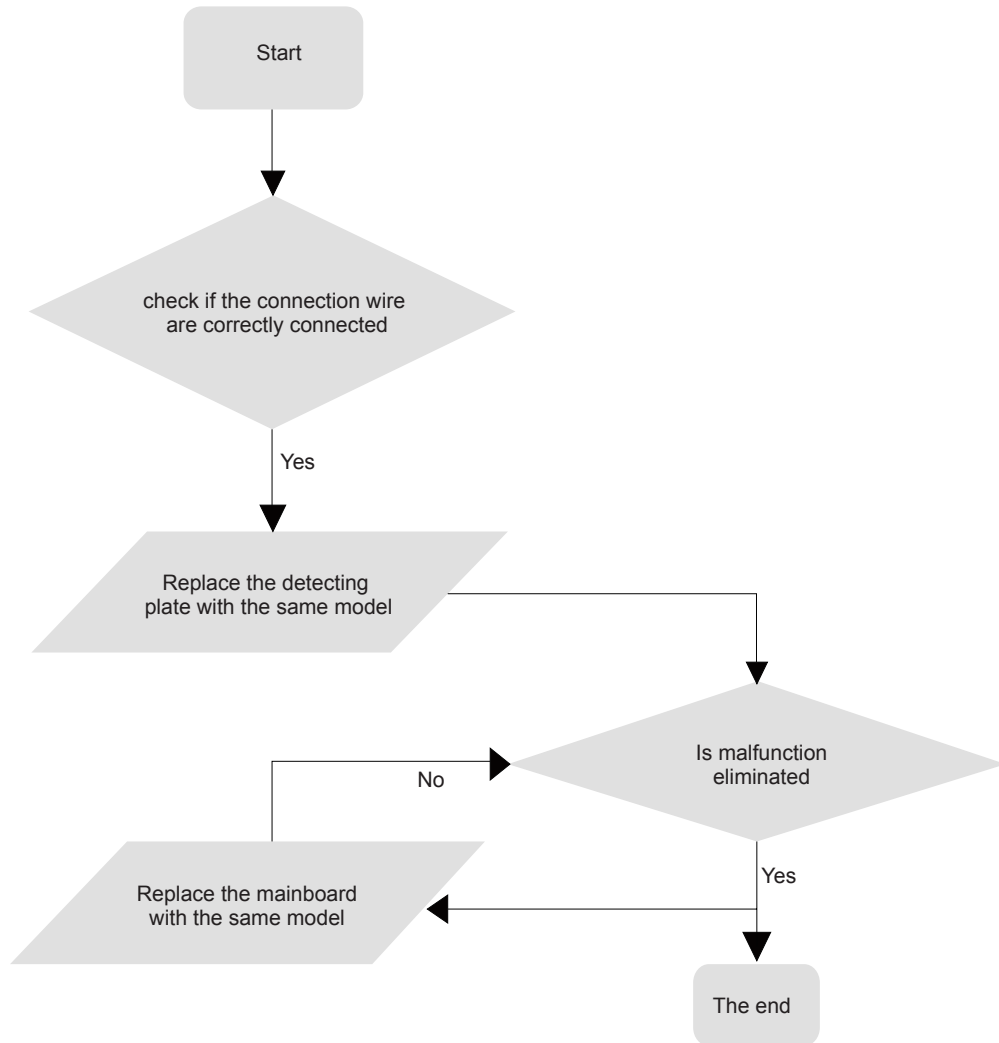

●Outdoor unit:

1.Capacity charging malfunction (outdoor unit malfunction) (AP1 below is control board of outdoor unit)

Main detection point:

- Detect if the voltage of L and N terminal of wiring board is between 210AC-240AC by alternating voltage meter;
- Is reactor (L) well connected? Is connection wire loosened or pull-out? Is reactor (L) damaged?

Malfunction diagnosis process:

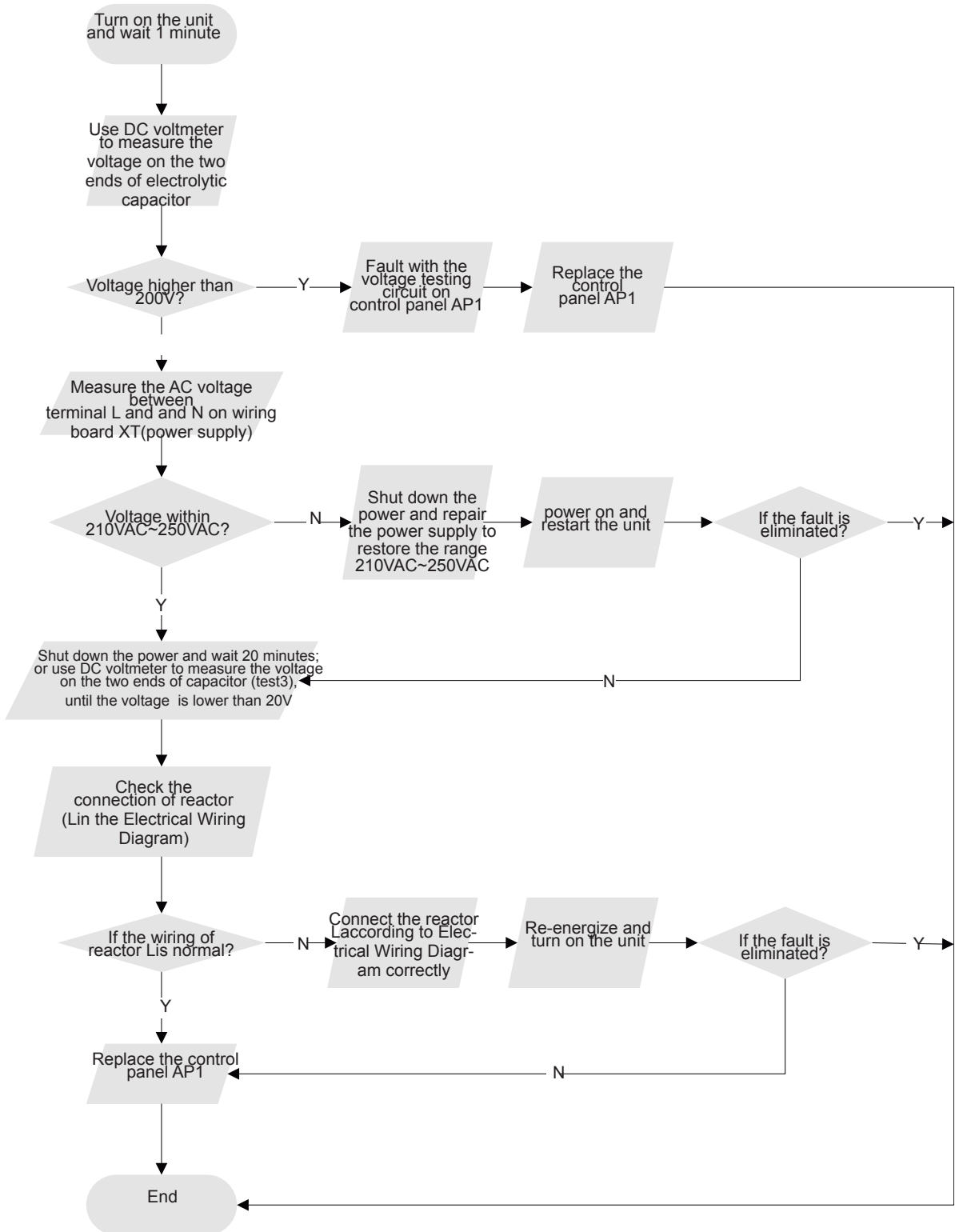

## 2.Diagnosis for anti-high temperature, overload protection (AP1 below is control board of outdoor unit)

Main detection point:

- If the outdoor ambient temperature is in normal range;
- If the indoor and outdoor fan is running normal;
- If the radiating environment of indoor and outdoor unit is well.

Malfunction diagnosis process:

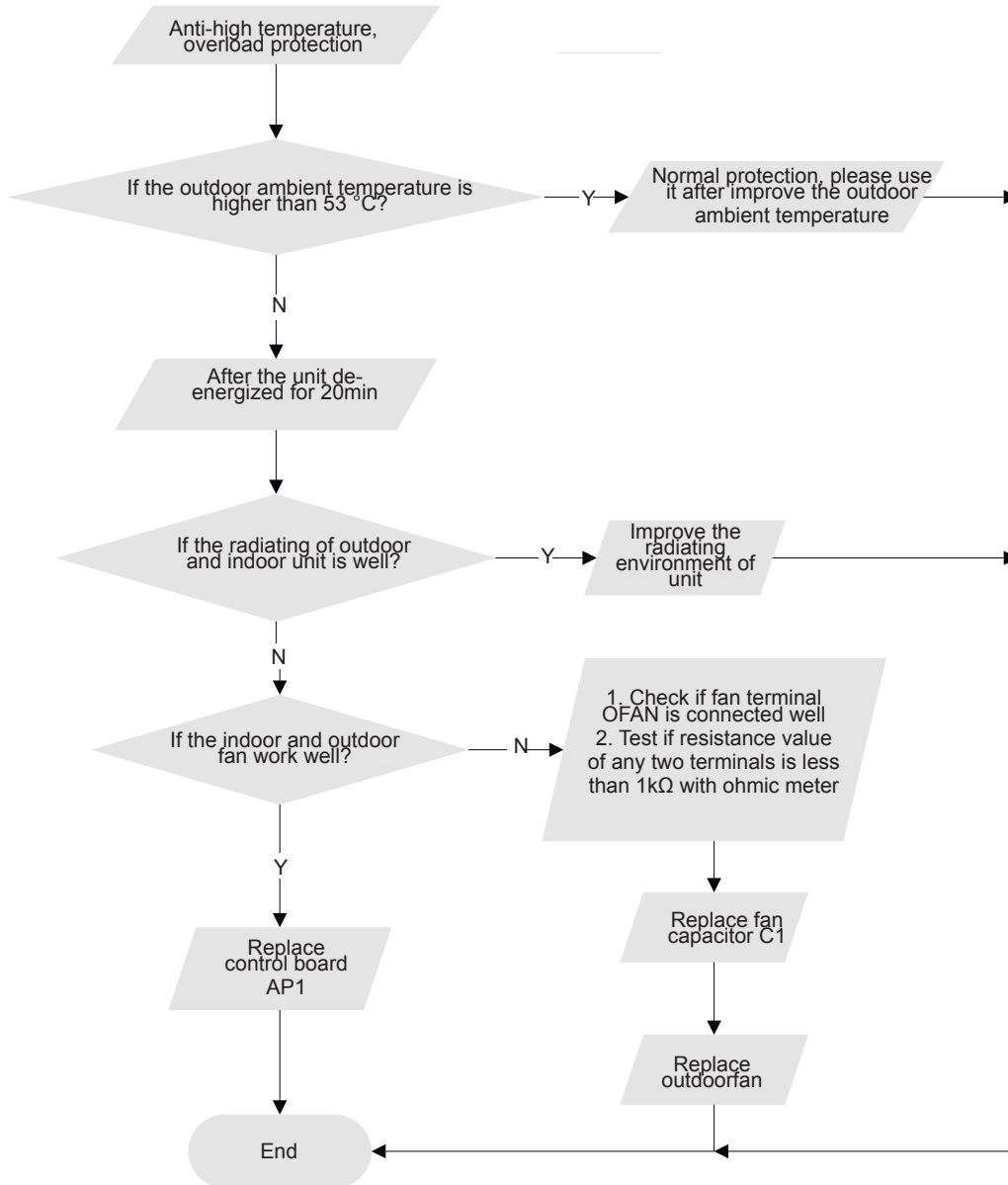

### 3. IPM protection, phase current overcurrent (the control board as below indicates the control board of outdoor unit) H5/P5

Mainly detect:

- (1) Compressor COMP terminal (2) voltage of power supply (3) compressor
- (4) Refrigerant-charging volume (5) air outlet and air inlet of outdoor/indoor unit

Troubleshooting:

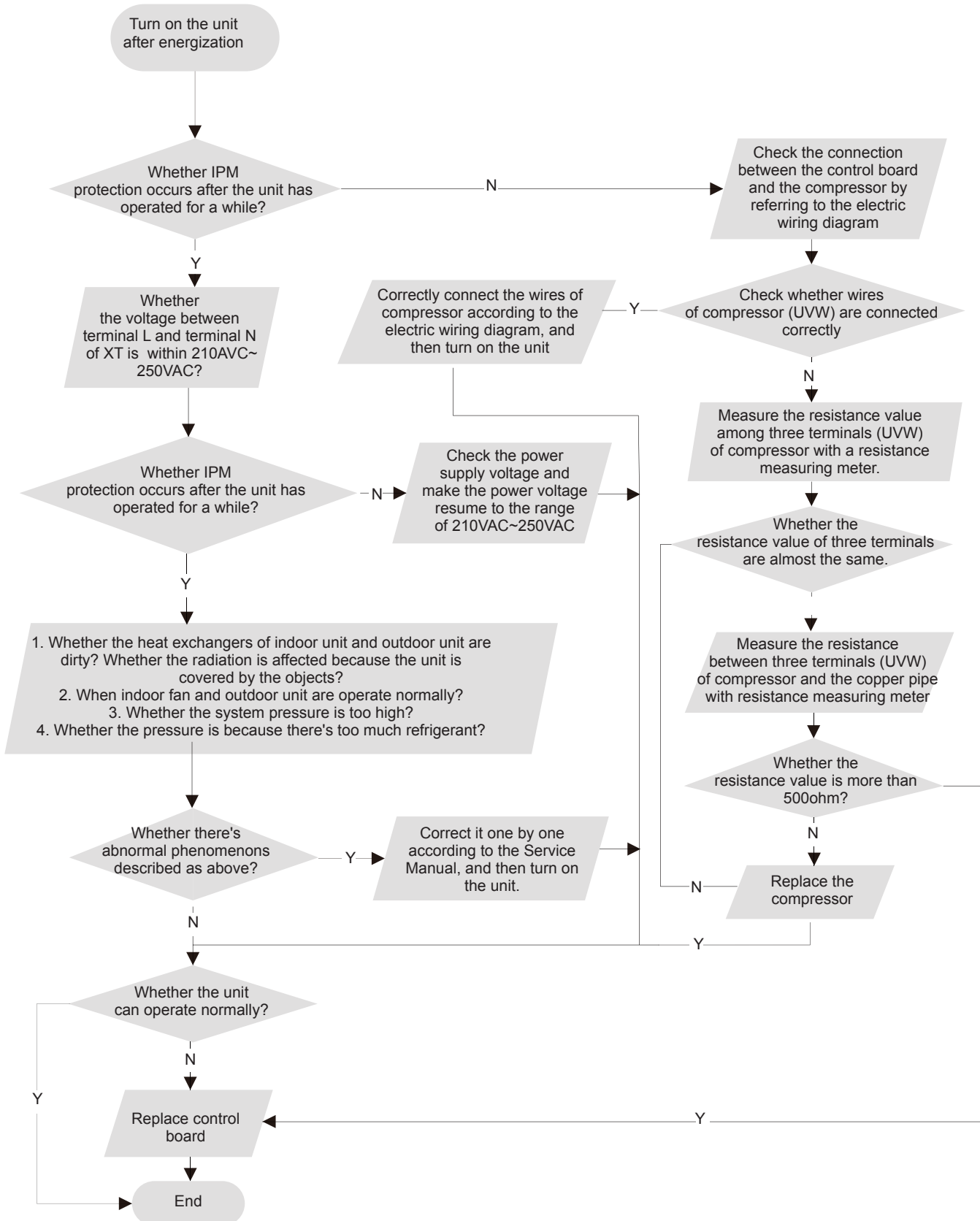

#### 4. Start-up failure (following AP1 for outdoor unit control board)

Mainly detect:

- Whether the compressor wiring is connected correct?
- Is compressor broken?
- Is time for compressor stopping enough?

Fault diagnosis process:

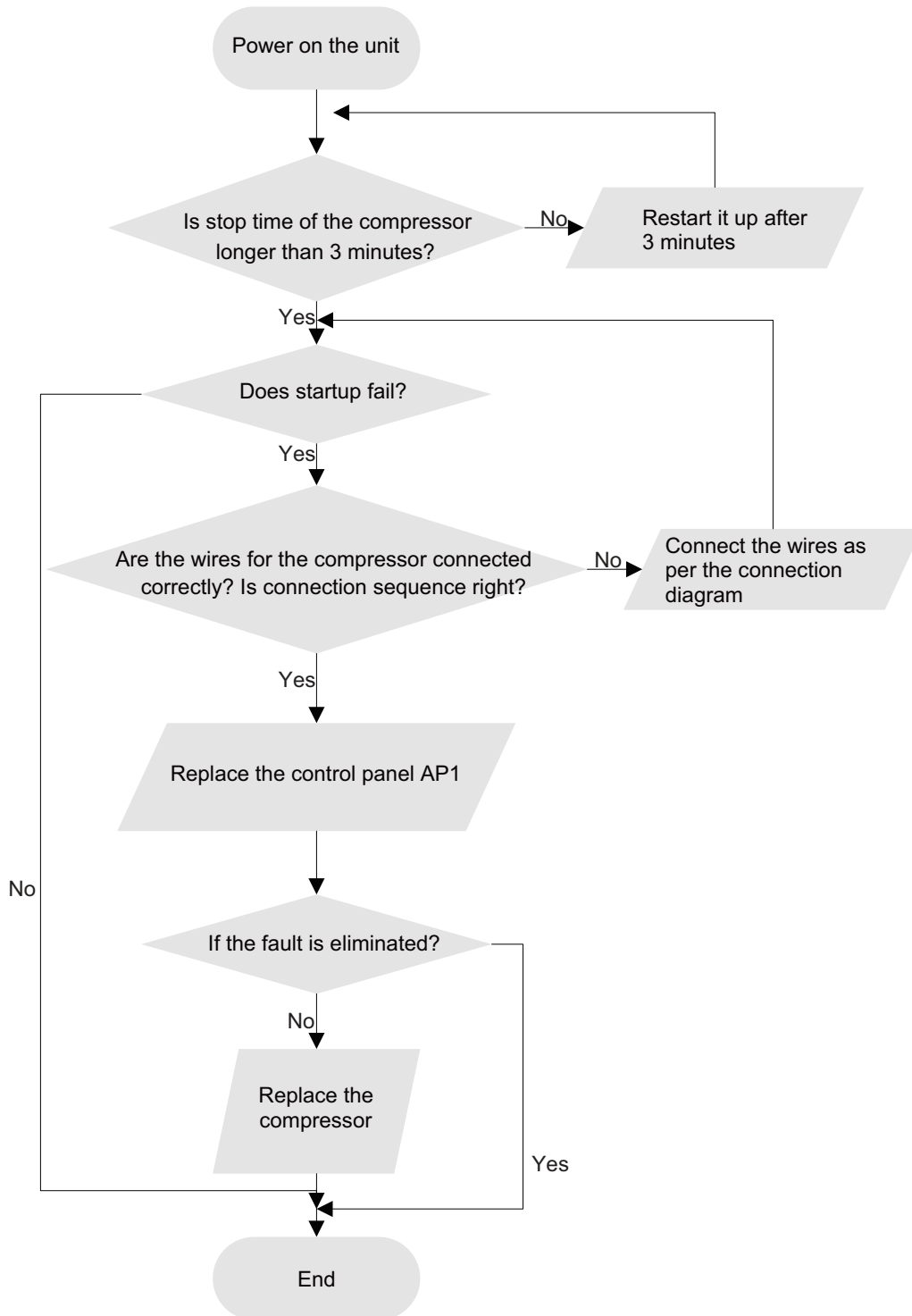

## 5. Out of step diagnosis for the compressor (AP1 hereinafter refers to the control board of the outdoor unit)

Mainly detect:

- Is the system pressure too high?
- Is the input voltage too low?

Fault diagnosis process:

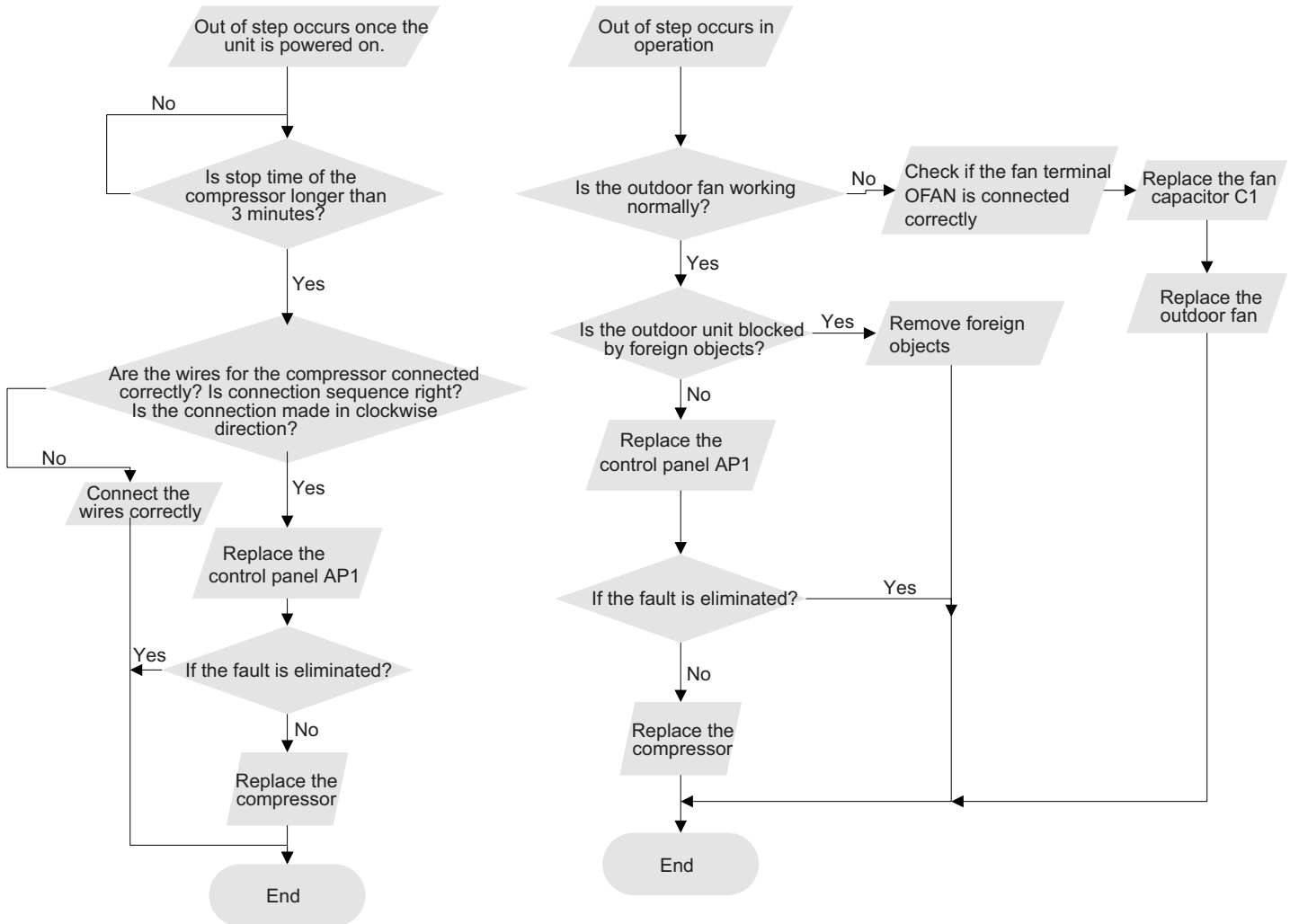

## 6. Overload and air exhaust malfunction diagnosis (following AP1 for outdoor unit control board)

Mainly detect:

- Is the PMV connected well or not? Is PMV damaged?
- Is refrigerant leaked?

Fault diagnosis process:

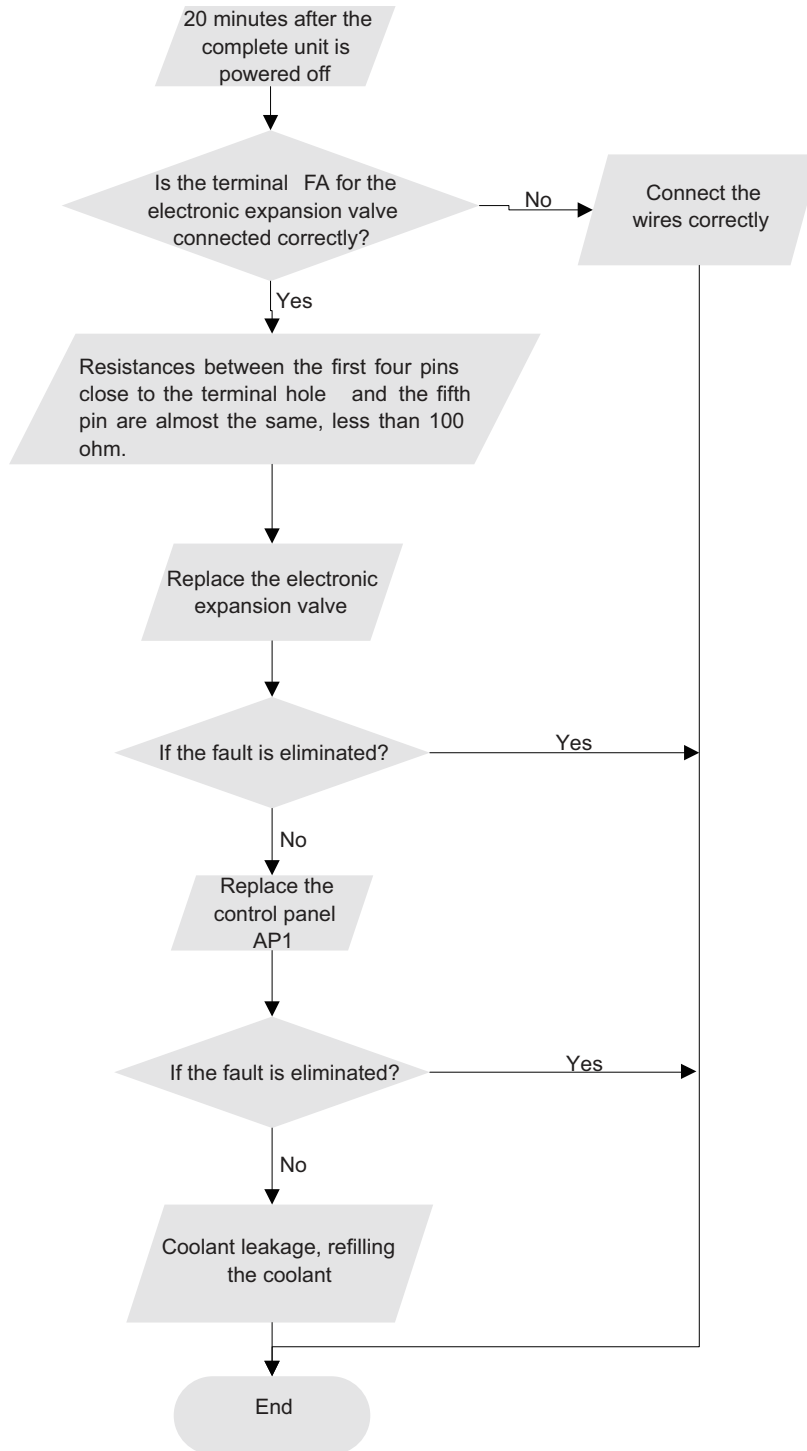



## 7. Communication malfunction: (following AP1 for outdoor unit control board)

Mainly detect:

- Is there any damage for the indoor unit mainboard communication circuit? Is communication circuit damaged?
- Detect the indoor and outdoor units connection wire and indoor and outdoor units inside wiring is connect well or not, if is there any damage?

Fault diagnosis process:

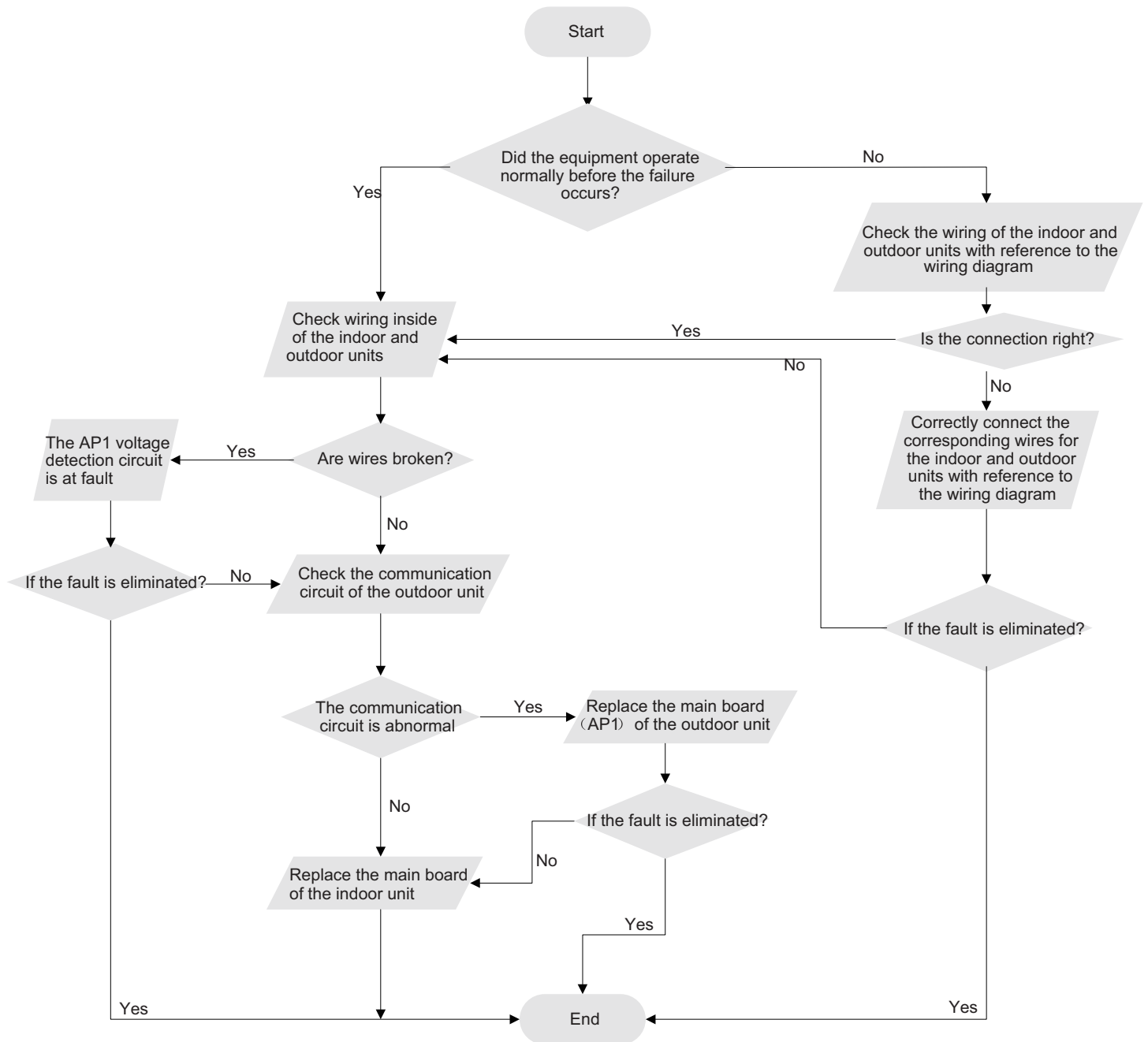

## 8. Malfunction of Overcurrent Protection

Main detection points:

- Is the supply voltage unstable with big fluctuation?
- Is the supply voltage too low with overload?
- Hardware trouble?

Malfunction diagnosis process:

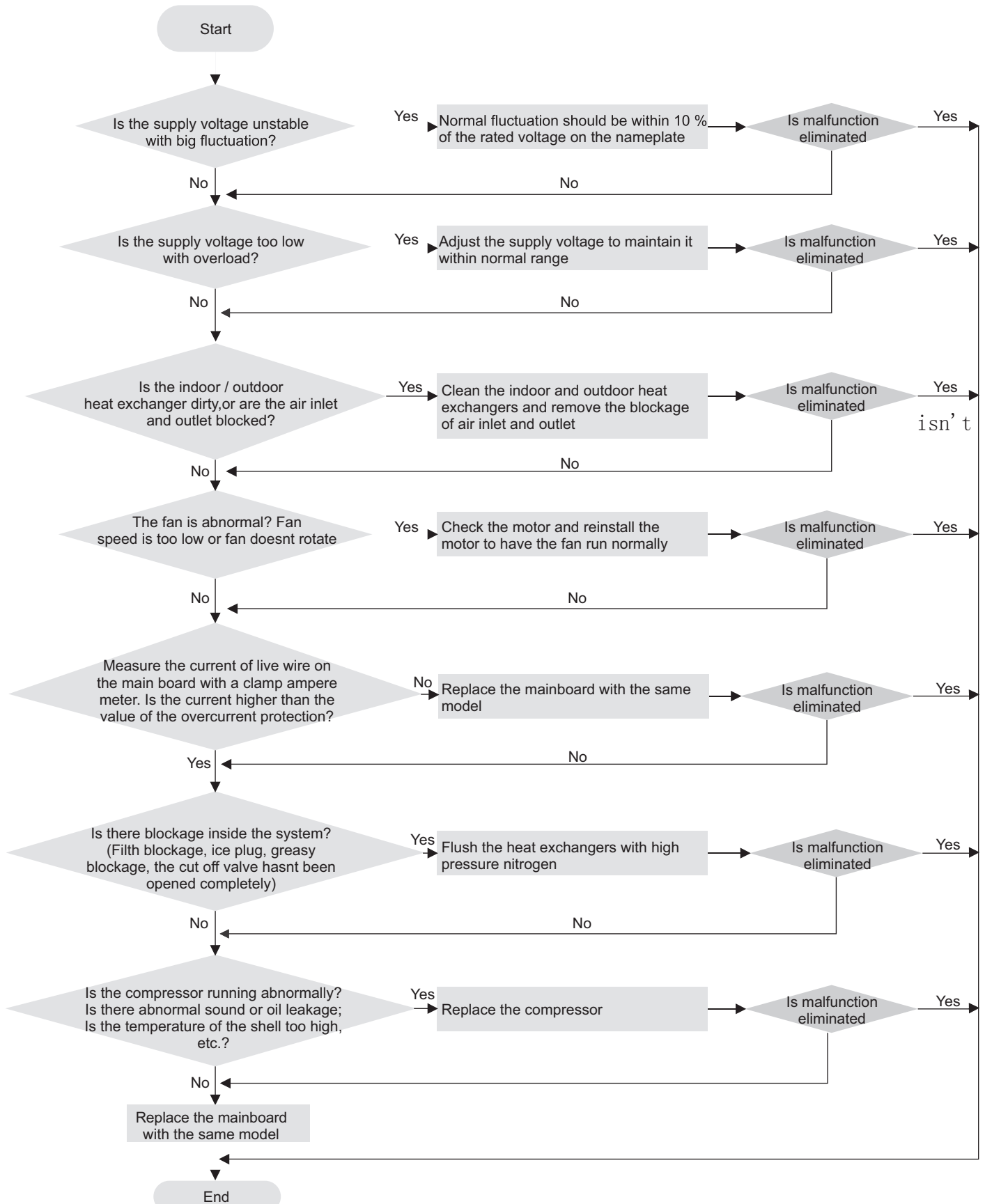

isn't

## 9.3 Troubleshooting for Normal Malfunction

### 1. Air Conditioner Can't be Started Up

Possible Causes	Discriminating Method (Air conditioner Status)	Troubleshooting
No power supply, or poor connection for power plug	After energization, operation indicator isn't bright and the buzzer can't give out sound	Confirm whether it's due to power failure. If yes, wait for power recovery. If not, check power supply circuit and make sure the power plug is connected well.
Wrong wire connection between indoor unit and outdoor unit, or poor connection for wiring terminals	Under normal power supply circumstances, operation indicator isn't bright after energization	Check the circuit according to circuit diagram and connect wires correctly. Make sure all wiring terminals are connected firmly
Electric leakage for air conditioner	After energization, room circuit breaker trips off at once	Make sure the air conditioner is grounded reliably Make sure wires of air conditioner is connected correctly Check the wiring inside air conditioner. Check whether the insulation layer of power cord is damaged; if yes, place the power cord.
Model selection for air switch is improper	After energization, air switch trips off	Select proper air switch
Malfunction of remote controller	After energization, operation indicator is bright, while no display on remote controller or buttons have no action.	Replace batteries for remote controller Repair or replace remote controller

### 2. Poor Cooling (Heating) for Air Conditioner

Possible Causes	Discriminating Method (Air conditioner Status)	Troubleshooting
Set temperature is improper	Observe the set temperature on remote controller	Adjust the set temperature
Rotation speed of the IDU fan motor is set too low	Small wind blow	Set the fan speed at high or medium
Filter of indoor unit is blocked	Check the filter to see its blocked	Clean the filter
Installation position for indoor unit and outdoor unit is improper	Check whether the installation position is proper according to installation requirement for air conditioner	Adjust the installation position, and install the rainproof and sunproof for outdoor unit
Refrigerant is leaking	Discharged air temperature during cooling is higher than normal discharged wind temperature; Discharged air temperature during heating is lower than normal discharged wind temperature; Units pressure is much lower than regulated range	Find out the leakage causes and deal with it. Add refrigerant.
Malfunction of 4-way valve	Blow cold wind during heating	Replace the 4-way valve
Malfunction of capillary	Discharged air temperature during cooling is higher than normal discharged wind temperature; Discharged air temperature during heating is lower than normal discharged wind temperature; Unit pressure is much lower than regulated range. If refrigerant isn't leaking, part of capillary is blocked	Replace the capillary
Flow volume of valve is insufficient	The pressure of valves is much lower than that stated in the specification	Open the valve completely
Malfunction of horizontal louver	Horizontal louver can't swing	Refer to point 3 of maintenance method for details
Malfunction of the IDU fan motor	The IDU fan motor can't operate	Refer to troubleshooting for H6 for maintenance method in details
Malfunction of the ODU fan motor	The ODU fan motor can't operate	Refer to point 4 of maintenance method for details
Malfunction of compressor	Compressor can't operate	Refer to point 5 of maintenance method for details

### 3. Horizontal Louver Can't Swing

Possible Causes	Discriminating Method (Air conditioner Status)	Troubleshooting
Wrong wire connection, or poor connection	Check the wiring status according to circuit diagram	Connect wires according to wiring diagram to make sure all wiring terminals are connected firmly
Stepping motor is damaged	Stepping motor can't operate	Repair or replace stepping motor
Main board is damaged	Others are all normal, while horizontal louver can't operate	Replace the main board with the same model

#### 4. ODU Fan Motor Can't Operate

Possible causes	Discriminating method (air conditioner status)	Troubleshooting
Wrong wire connection, or poor connection	Check the wiring status according to circuit diagram	Connect wires according to wiring diagram to make sure all wiring terminals are connected firmly
Capacity of the ODU fan motor is damaged	Measure the capacity of fan capacitor with an universal meter and find that the capacity is out of the deviation range indicated on the nameplate of fan capacitor.	Replace the capacity of fan
Power voltage is a little low or high	Use universal meter to measure the power supply voltage. The voltage is a little high or low	Suggest to equip with voltage regulator
Motor of outdoor unit is damaged	When unit is on, cooling/heating performance is bad and ODU compressor generates a lot of noise and heat.	Change compressor oil and refrigerant. If no better, replace the compressor with a new one

#### 5. Compressor Can't Operate

Possible causes	Discriminating method (air conditioner status)	Troubleshooting
Wrong wire connection, or poor connection	Check the wiring status according to circuit diagram	Connect wires according to wiring diagram to make sure all wiring terminals are connected firmly
Capacity of compressor is damaged	Measure the capacity of fan capacitor with an universal meter and find that the capacity is out of the deviation range indicated on the nameplate of fan capacitor.	Replace the compressor capacitor
Power voltage is a little low or high	Use universal meter to measure the power supply voltage. The voltage is a little high or low	Suggest to equip with voltage regulator
Coil of compressor is burnt out	Use universal meter to measure the resistance between compressor terminals and it's 0	Repair or replace compressor
Cylinder of compressor is blocked	Compressor can't operate	Repair or replace compressor

#### 6. Air Conditioner is Leaking

Possible causes	Discriminating method (air conditioner status)	Troubleshooting
Drain pipe is blocked	Water leaking from indoor unit	Eliminate the foreign objects inside the drain pipe
Drain pipe is broken	Water leaking from drain pipe	Replace drain pipe
Wrapping is not tight	Water leaking from the pipe connection place of indoor unit	Wrap it again and bundle it tightly

#### 7. Abnormal Sound and Vibration

Possible causes	Discriminating method (air conditioner status)	Troubleshooting
When turn on or turn off the unit, the panel and other parts will expand and theres abnormal sound	Theres the sound of "PAPA"	Normal phenomenon. Abnormal sound will disappear after a few minutes.
When turn on or turn off the unit, theres abnormal sound due to flow of refrigerant inside air conditioner	Water-running sound can be heard	Normal phenomenon. Abnormal sound will disappear after a few minutes.
Foreign objects inside the indoor unit or therere parts touching together inside the indoor unit	Theres abnormal sound fro indoor unit	Remove foreign objects. Adjust all parts position of indoor unit, tighten screws and stick damping plaster between connected parts
Foreign objects inside the outdoor unit or therere parts touching together inside the outdoor unit	Theres abnormal sound fro outdoor unit	Remove foreign objects. Adjust all parts position of outdoor unit, tighten screws and stick damping plaster between connected parts
Short circuit inside the magnetic coil	During heating, the way valve has abnormal electromagnetic sound	Replace magnetic coil
Abnormal shake of compressor	Outdoor unit gives out abnormal sound	Adjust the support foot mat of compressor, tighten the bolts
Abnormal sound inside the compressor	Abnormal sound inside the compressor	If add too much refrigerant during maintenance, please reduce refrigerant properly. Replace compressor for other circumstances.

# 10. Exploded View and Parts List

## 10.1 Indoor Unit

AUC

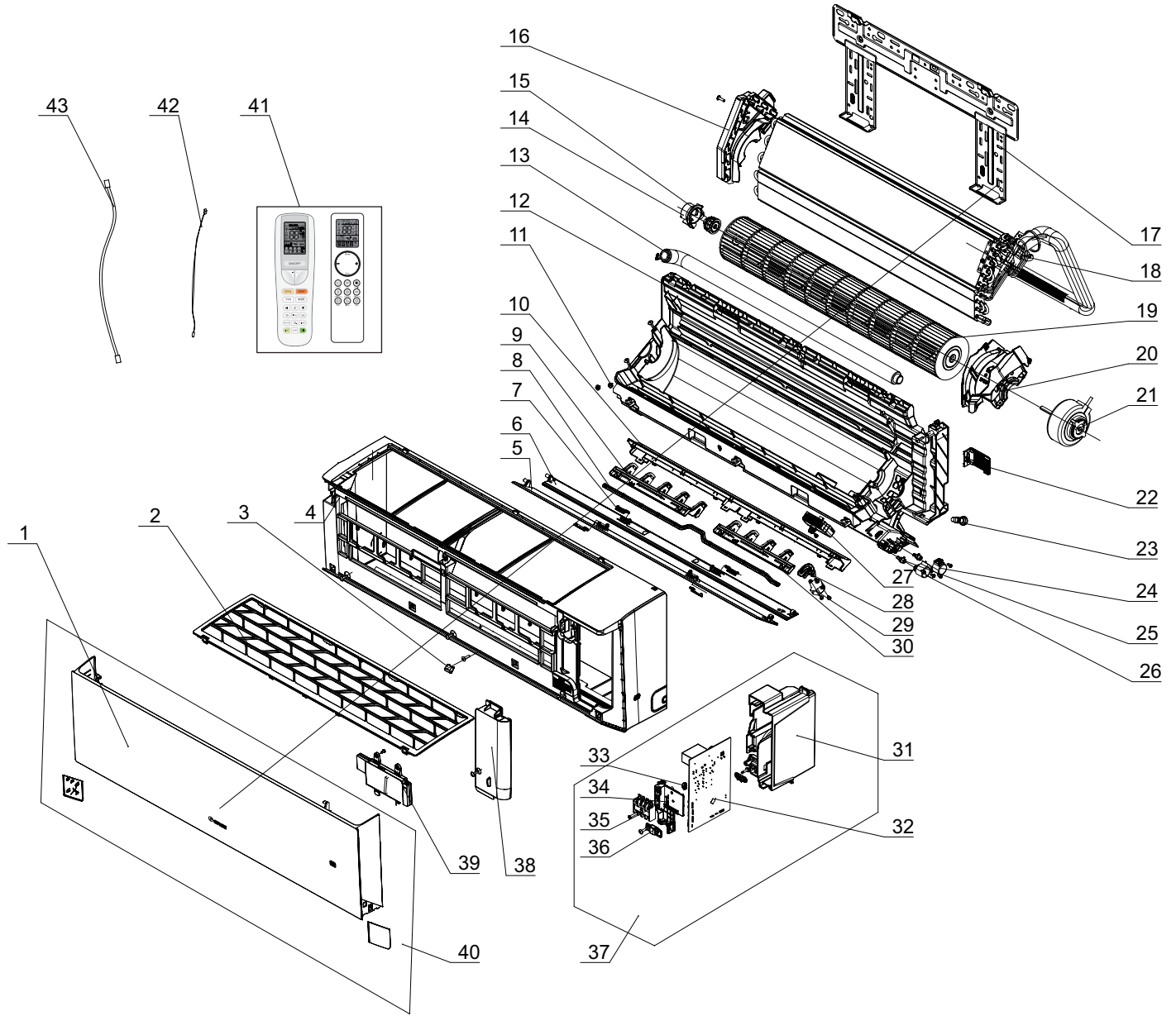

The component picture is only for reference; please refer to the actual product.

NO.	Description
1	Front Panel
2	Filter Sub-Assy
3	Screw Cover
4	Front Case
5	Guide Louver (upper)
6	Guide Louver (lower)
7	Plug Pin
8	Swing Lever
9	Air Louver (left)
10	Helicoid Tongue
11	Left Axile Bush
12	Rear Case
13	Drainage Hose
14	Ring of Bearing
15	O-Gasket sub-assy of Bearing
16	Evaporator Support
17	Wall Mounting Frame
18	Wall Mounting Frame
19	Cross Flow Fan
20	Motor Press Plate
21	Brushless DC Motor
22	Connecting pipe clamp

NO.	Description
23	Rubber Plug (Water Tray)
24	Stepping Motor
25	Crank
26	Stepping Motor
27	Plasmacluster Ion
28	Air Louver
29	Stepping Motor
30	Air Louver(right)
31	Electric Box
32	Main Board
33	Jumper
34	Supporter
35	Terminal Board
36	Cable Clamp 2
37	Electric Box Assy
38	Electric Box Cover
39	Display Board
40	Front Panel Assy
41	Remote Controller
42	Temperature Sensor
43	Connecting Cable

Some models may not contain some parts, please refer to the actual product.

AUD

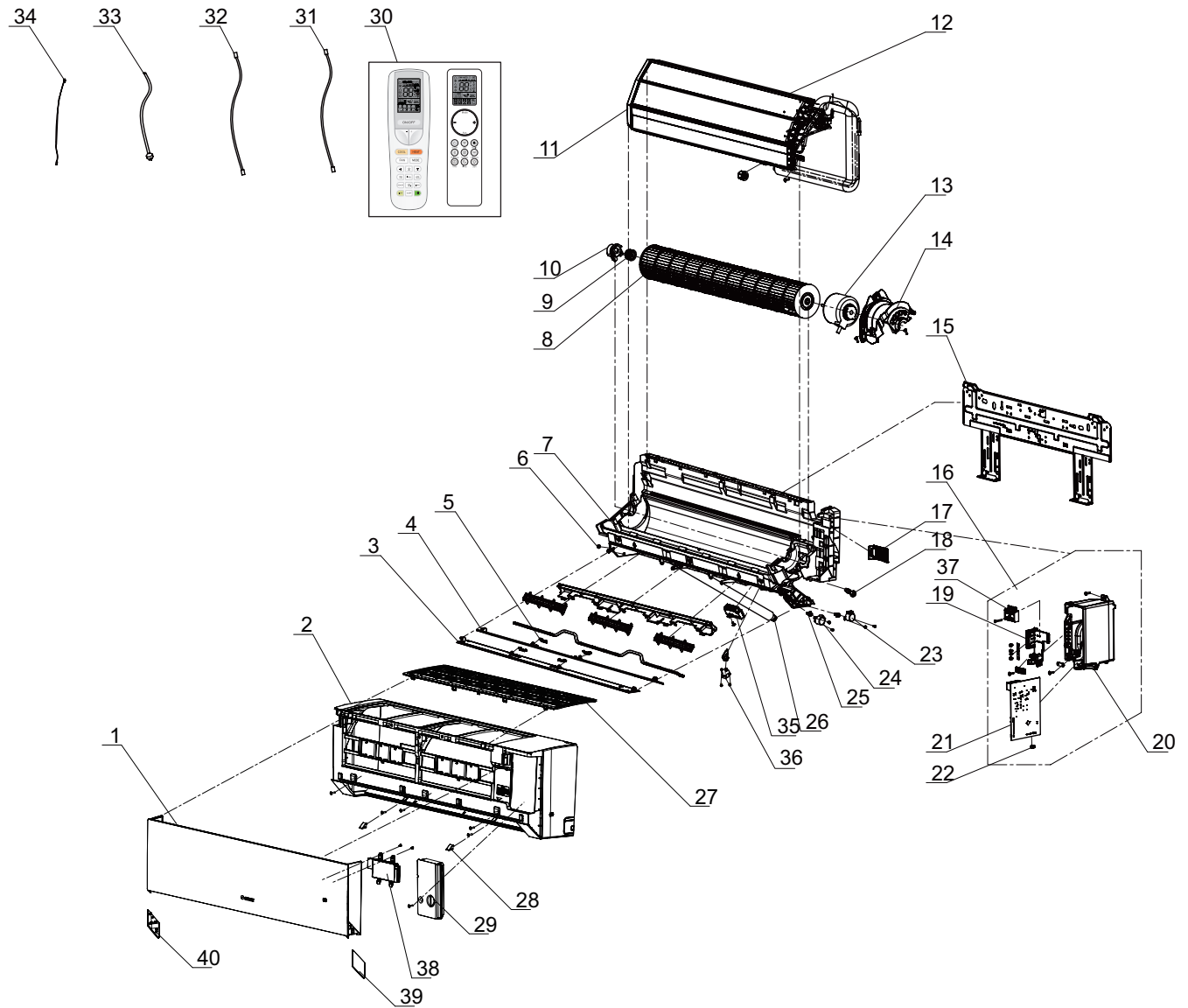

The component picture is only for reference; please refer to the actual product.

NO.	Description
1	Front Panel
2	Front Case Assy
3	Guide Louver Sub-assy 1
4	Guide Louver Sub-assy 2
5	Plug Pin
6	Left Axile Bush
7	Rear Case
8	Cross Flow Fan
9	Ring of Bearing
10	O-Gasket sub-assy of Bearing
11	Evaporator Support
12	Evaporator Assy
13	Fan Motor
14	Motor Press Plate
15	Wall Mounting Frame Sub-assy
16	Electric Box Assy
17	Connecting pipe clamp
18	Rubber Plug (Water Tray)
19	Supporter
20	Electric Box

NO.	Description
21	Main Board
22	Jumper
23	Stepping Motor
24	Stepping Motor
25	Crank
26	Drainage Hose
27	Filter Sub-Assy
28	Screw Cover
29	Electric Box Cover
30	Remote Controller
31	Connecting Cable
32	Connecting Cable
33	Power Cord
34	Temperature Sensor
35	Plasmacluster Ion
36	Stepping Motor
37	Terminal Board
38	Display Board
39	Right Decorative Board
40	Left Decorative Board

Some models may not contain some parts, please refer to the actual product.



## 10.2 Outdoor Unit

GWH09AUCXB-K6DNA1A/O

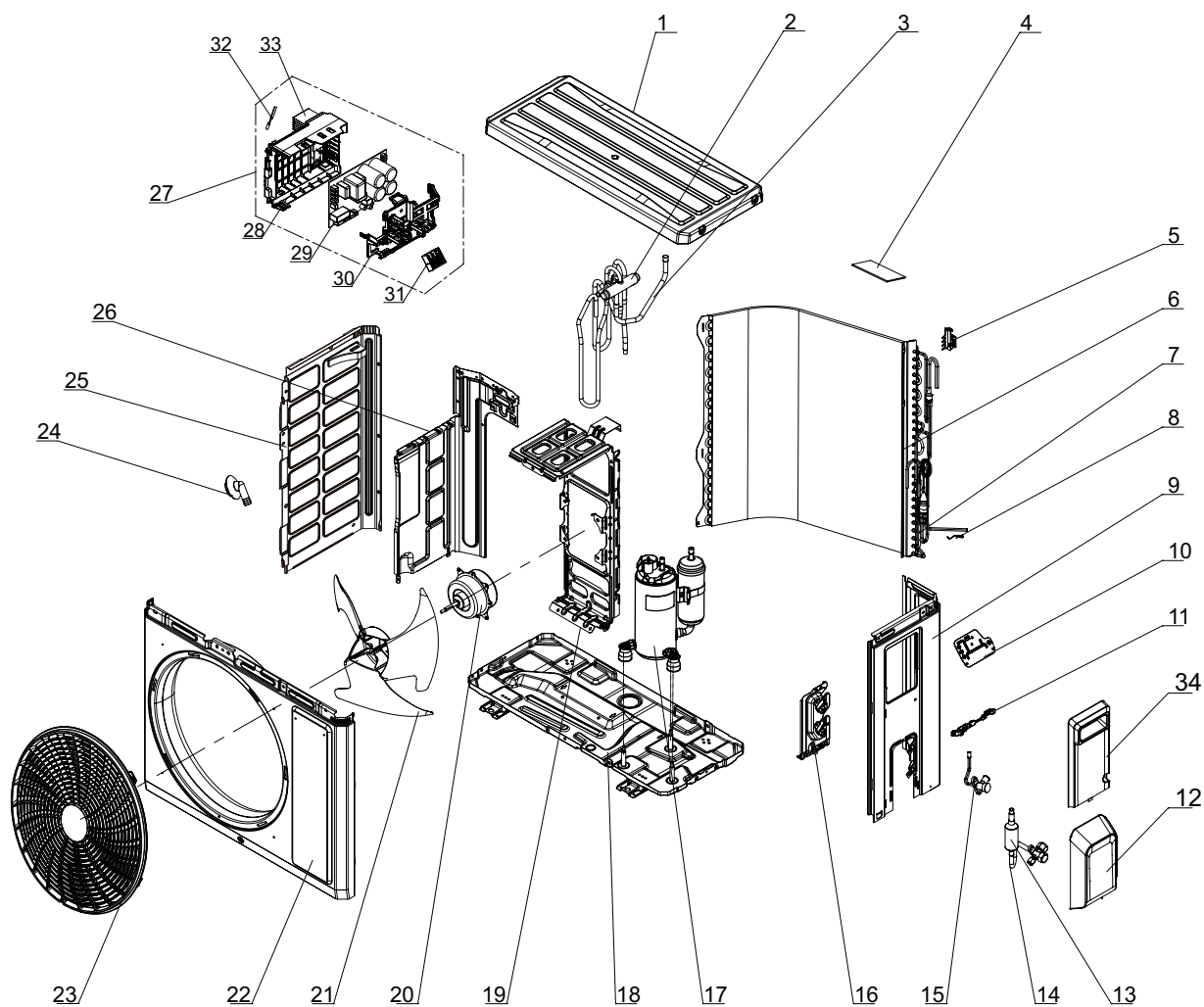

The component is only for reference; please refer to the actual product

NO.	Description
1	Coping
2	4-Way Valve
3	4-Way Valve Assy
4	Sponge(Condenser)
5	Temperature Sensor Support
6	Condenser Assy
7	Capillary Sub-assy
8	Sensor Insert
9	Right Side Plate
10	Earthing Plate Sub-Assy
11	Wire Clamp
12	Valve Cover
13	Silencer
14	Cut-off valve 3/8(N)
15	Cut-off valve 1/4(N)
16	Valve Support
17	Compressor and Fittings

NO.	Description
18	Chassis Sub-assy
19	Motor Support
20	Fan Motor
21	Axial Flow Fan
22	Cabinet
23	Front Grill
24	Drainage Joint(ODU)
25	Left Side Plate
26	Clapboard
27	Electric Box Assy
28	Electric Box
29	Main Board
30	Electric Box Cover
31	Terminal Board
32	Temperature Sensor
33	Raidator
34	Handle (Right)

Some models may not contain some parts, please refer to the actual product.

GWH12AUCXB-K6DNA1A/O

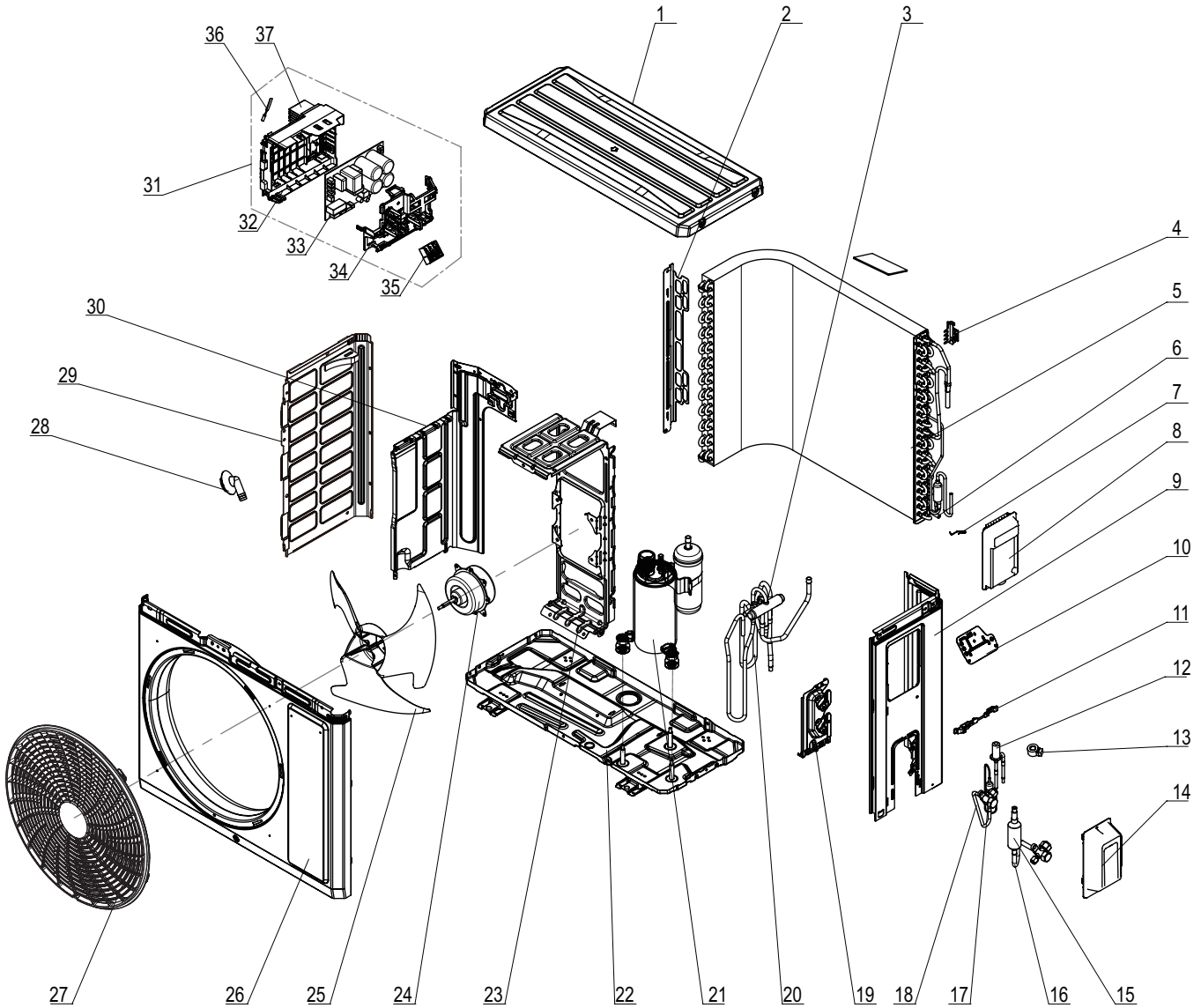

The component is only for reference; please refer to the actual product

NO.	Description
1	Coping
2	Supporting Board(Condenser)
3	4-Way Valve
4	Temperature Sensor Support
5	Condenser Assy
6	Temp Sensor Sleevling
7	Sensor Insert
8	Handle
9	Right Side Plate
10	Earthing Plate Sub-assy
11	Wire Clamp
12	Electronic Expansion Valve
13	Electric Expand Valve Fitting
14	Valve Cover
15	Silencer
16	Cut off Valve Sub-Assy
17	Strainer
18	Cut off Valve Assy
19	Valve Support

NO.	Description
20	4-Way Valve Assy
21	Compressor and Fittings
22	Chassis Sub-assy
23	Motor Support
24	Brushless DC Motor
25	Axial Flow Fan
26	Cabinet
27	Front Grill
28	Drainage Joint(ODU)
29	Left Side Plate
30	Clapboard
31	Electric Box Assy
32	Electric Box
33	Main Board
34	Electric Box Cover
35	Terminal Board
36	Temperature Sensor
37	Radiator

Some models may not contain some parts, please refer to the actual product.

GWH18AUDXD-K6DNA1A/O      GWH12AUCXD-K6DNA1C/O

(The front grill appearance is for reference only)

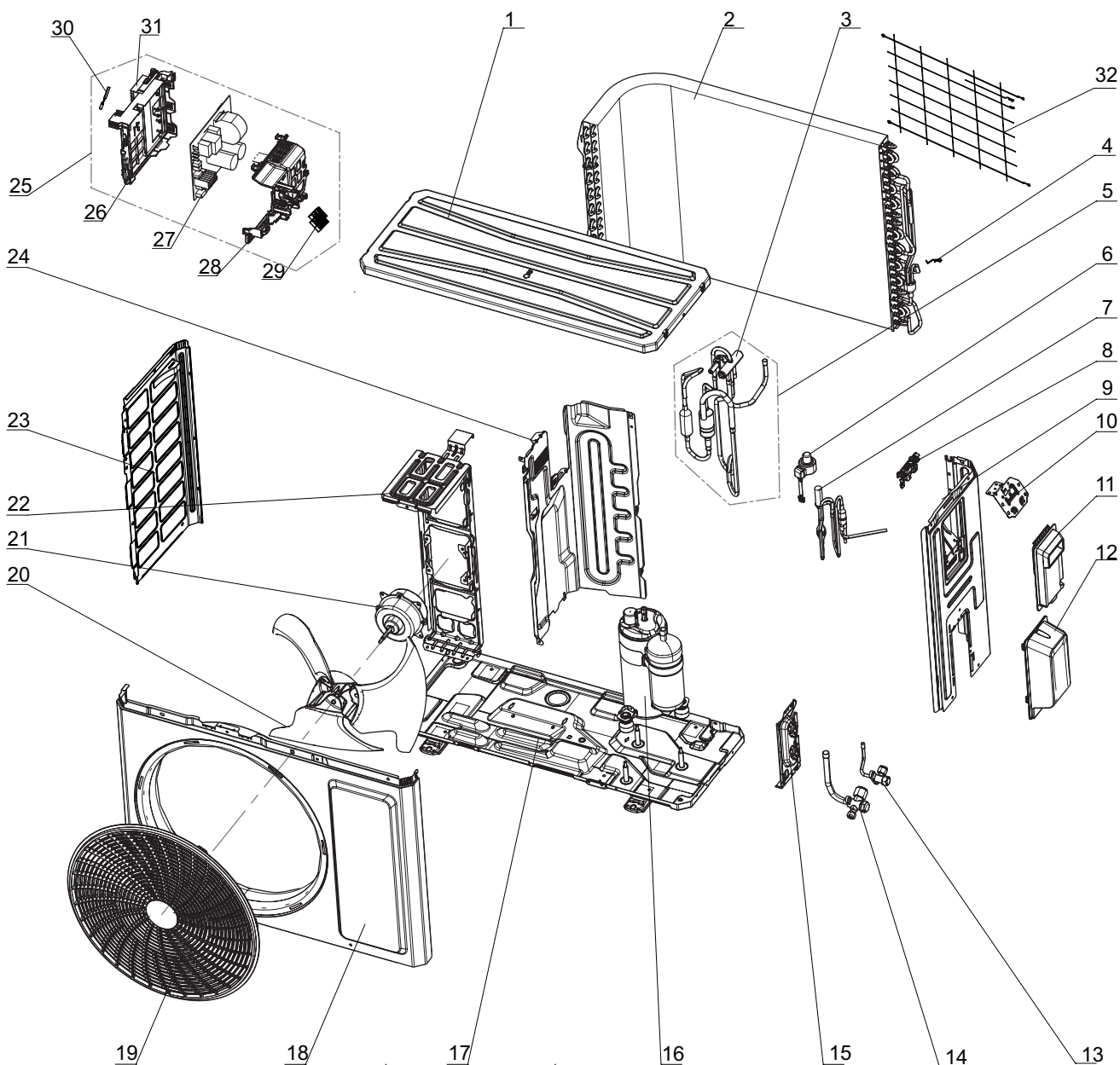

The component is only for reference; please refer to the actual product

NO.	Description
1	Top Cover Assy
2	Condenser Assy
3	4-Way Valve
4	Tempreture Sensor clamp
5	4-Way Valve Assy
6	Electric Expand Valve Fitting
7	Electric Expansion Valve Sub-Assy
8	Wire Clamp
9	Right Side Plate
10	Earthing Plate Sub-assy

NO.	Description
11	Handle
12	Valve Cover
13	Cut-off valve 1/4(N)
14	Cut-off valve 1/2(N)
15	Valve Support
16	Compressor and Fittings
17	Chassis Sub-assy
18	Cabinet
19	Front Grill
20	Axial Flow Fan
21	Brushless DC Motor

NO.	Description
22	Motor Support
23	Left Side Plate
24	Clapboard Assy
25	Electric Box Assy
26	Electric Box
27	Main Board
28	Electric Box Cover
29	Terminal Board
30	Temperature Sensor
31	Radiator

Some models may not contain some parts, please refer to the actual product.

GWH24AUDXF-K6DNA1A/O

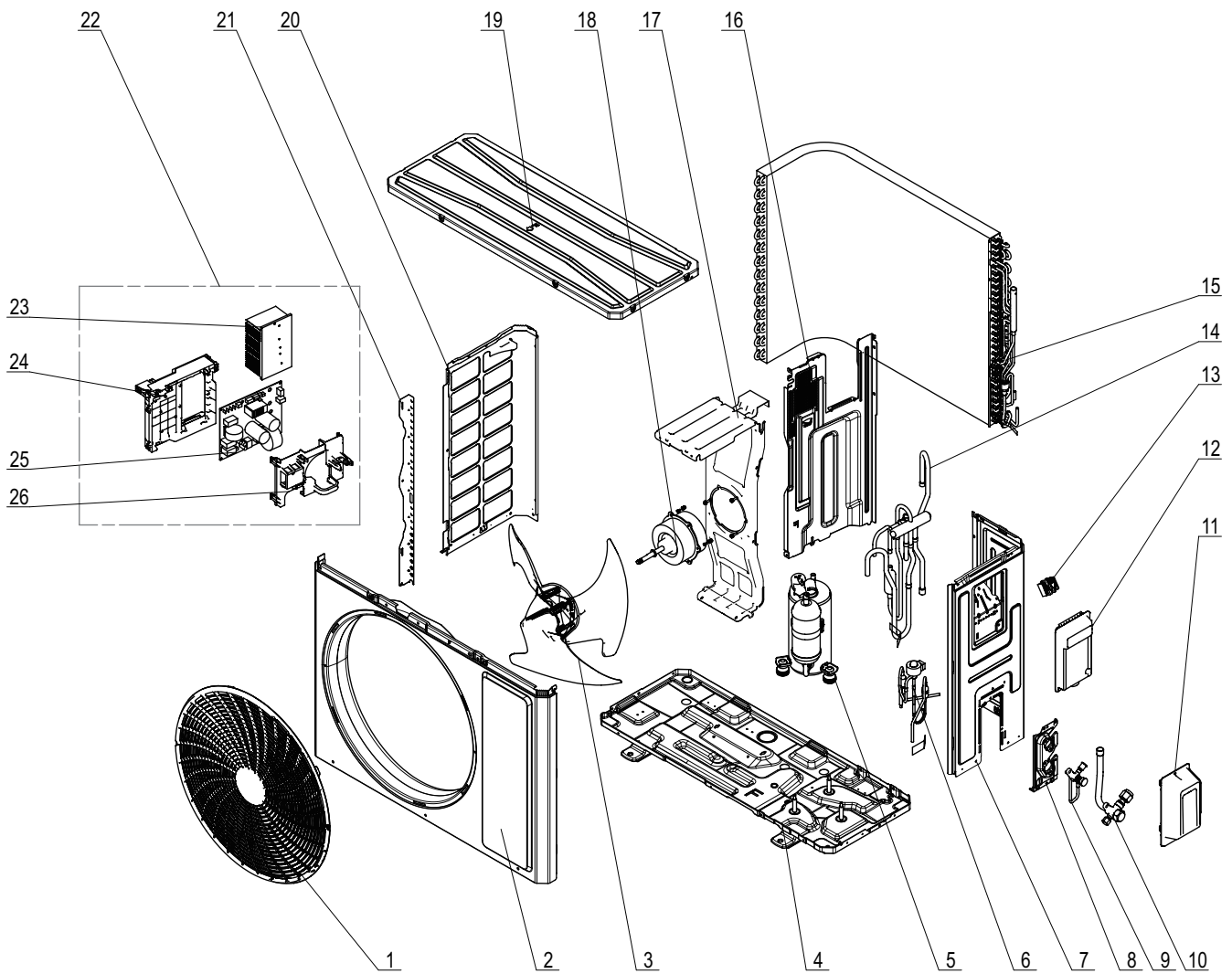

The component is only for rerefence;please refer to the actual product

NO.	Description
1	Front Grill
2	Front Panel
3	Axial Flow Fan
4	Chassis Sub-assy
5	Compressor and Fittings
6	Electronic Expansion Valve Assy
7	Right Side Plate
8	Valve Support
9	Cut-off valve 1/4(N)
10	Cut-off valve 5/8(N)
11	Valve Cover
12	Handle
13	Terminal Board

NO.	Description
14	4-Way Valve Assy
15	Condenser Assy
16	Clapboard Assy
17	Motor Support
18	Brushless DC Motor
19	Top Cover Assy
20	Left Side Plate
21	Condenser Left Border Plate
22	Electric Box Assy
23	Radiator
24	Electric Box
25	Main Board
26	Electric Box Cover

Some models may not contain some parts, please refer to the actual product.

# 11. Removal Procedure

## 11.1 Removal Procedure of Indoor Unit

09/12K



Note: Take A1 blue panel for example.

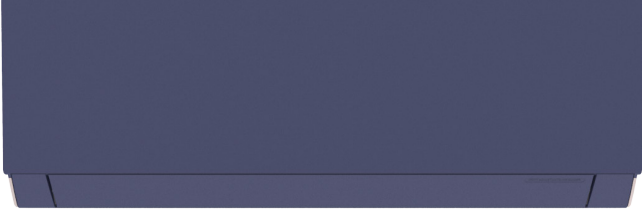
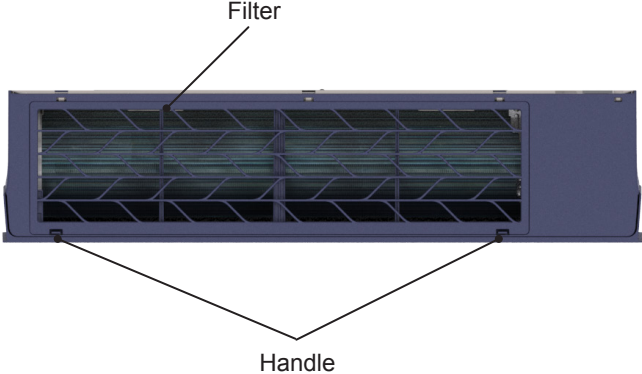
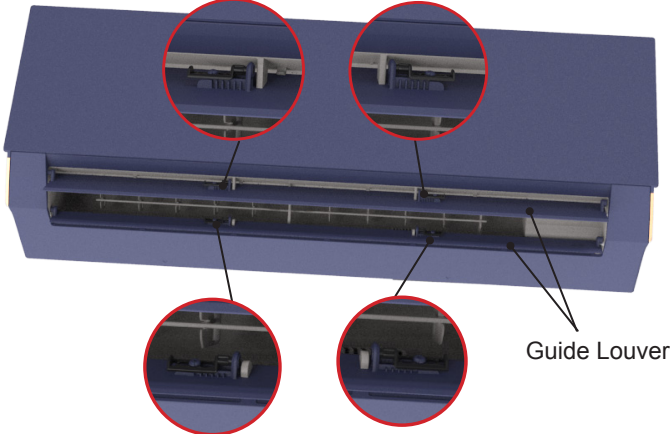

Caution: discharge the refrigerant completely before removal.

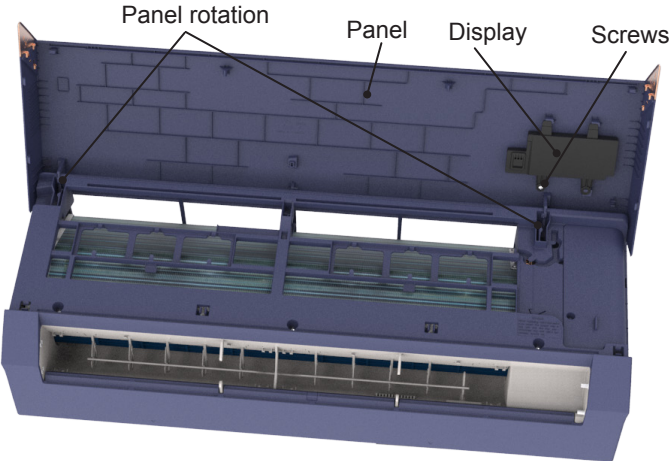
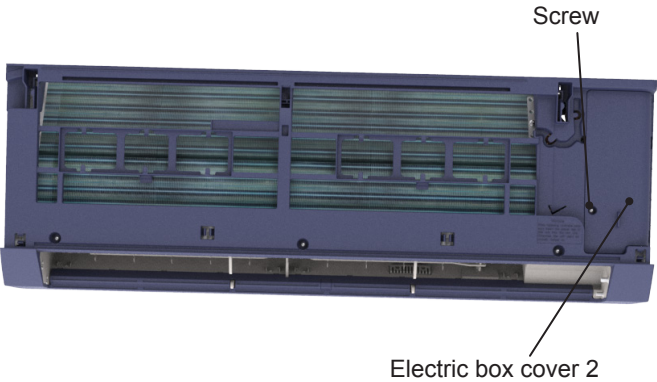
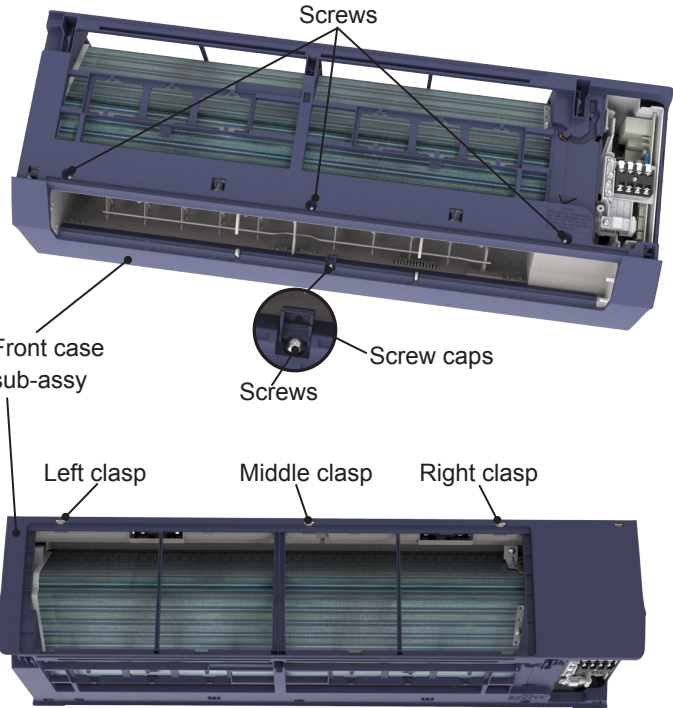
Step	Procedure
<p data-bbox="105 318 321 345">Before disassemble</p> <p data-bbox="183 585 675 646">Turn off the air conditioner and disconnect the power before disassemble the air conditioner.</p>	
<p data-bbox="105 886 277 912">1. Remove filter</p> <p data-bbox="183 1159 708 1251">Hold the handle on the filter, pull it upwards to let the clasp at the top part of the filter loose, push it forwards and then the filter can be pulled out.</p>	
<p data-bbox="105 1498 537 1524">2. Remove upper and lower guide louver</p> <p data-bbox="183 1738 784 1852">Push out the plug pin on upper and lower guide louver, Bend the guide louver with hand and then separate the guide louver from the crank shaft of step motor to remove it.</p>	

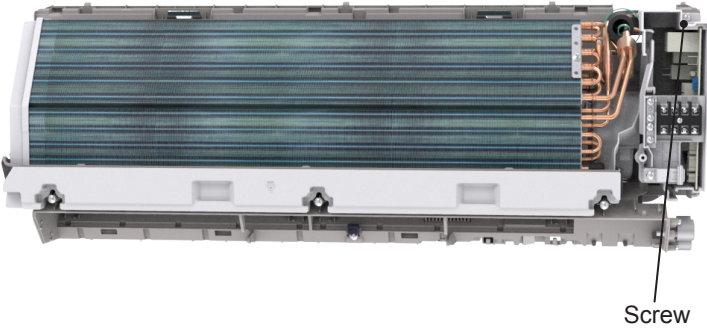
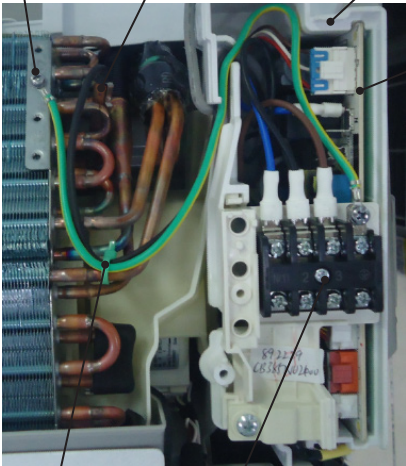
Step	Procedure
<p>3.Remove panel</p>	<p>Open the front panel; separate the panel rotation shaft from the groove fixing the front panel and then removes the front panel.</p> <p>Note: The display of some models is fixed on the panel; unscrew the screws fixing the display on the panel before removing the panel.</p> 
<p>4.Remove electric box cover 2</p>	<p>Remove the screws on the electric box cover 2 to remove the electric box cover 2.</p> 
<p>5.Remove front case sub-assy</p> <p>a</p> <p>Remove the screws fixing front case.</p> <p>Note: (1) Open the screw caps before removing the screws around the air outlet. (2) The quantity of screws fixing the front case sub-assy is different for different models.</p> <p>b</p> <p>Loosen the clasps at left, middle and right sides of front case. Lift the front case sub-assy upwards to remove it.</p>	

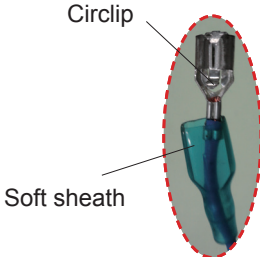
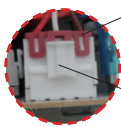
Step	Procedure
6.Remove electric box assy	
a	<p>Remove the screw fixing electric box assy.</p>
b	<p>① Cut off the wire binder and pull out the indoor tube temperature sensor.          ② Screw off one grounding screw.          ③ Remove the wiring terminals of motor, cold plasma generator and stepping motor.          ④ Remove the electric box assy.          ⑤ Screw off the screws that are locking each.</p> <p>Rotate the electric box assy. Twist off the screws that are locking the wire clip and loosen the power cord. Remove the wiring terminal of power cord. Lift up the main board and take it off.</p> <p>Instruction:Some wiring terminal of this products is with lock catch and other devices.The pulling method is as below:          1.Remove the soft sheath for some terminals at first, hold the circlip and then pull out the terminals,          2.Pull out the holder for some terminals at first(holder is not available for some wiring terminal).hold the connector and then pull the terminal.</p>    
c	

Step	Procedure
5.Remove panel	
a	<p>Remove 3 screws fixing evaporator assy.</p>
b	<p>At the back of the unit, Loosen the clasp of the connection pipe clamp and then remove the connection pipe clamp.</p>
c	<p>First remove the left side of evaporator from the groove of bottom shell and then remove the right side from the clasp on the bottom shell.</p>
d	<p>Adjust the position of connection pipe on evaporator slightly and then lift the evaporator upwards to remove it.</p>

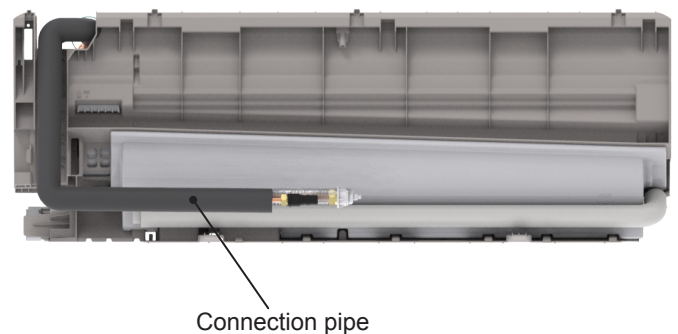
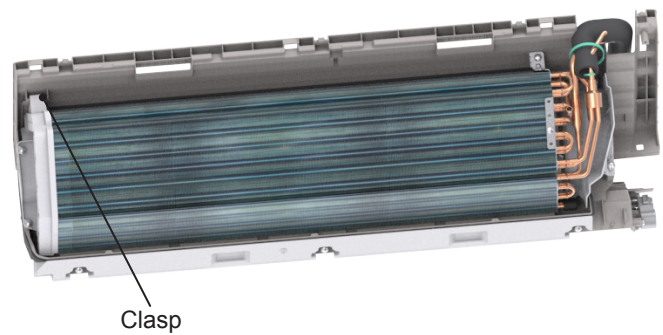
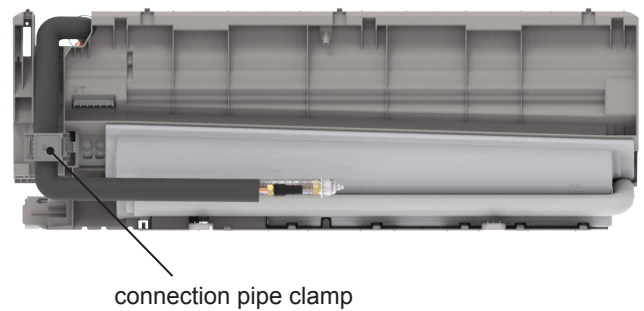
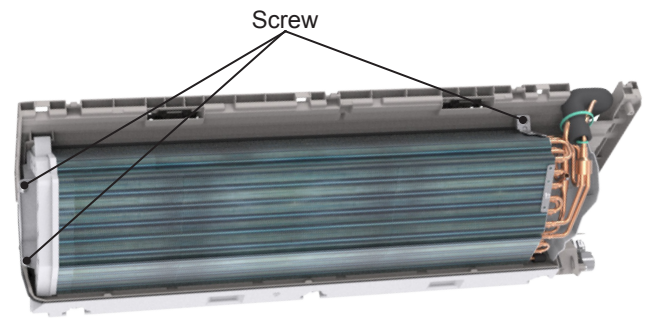



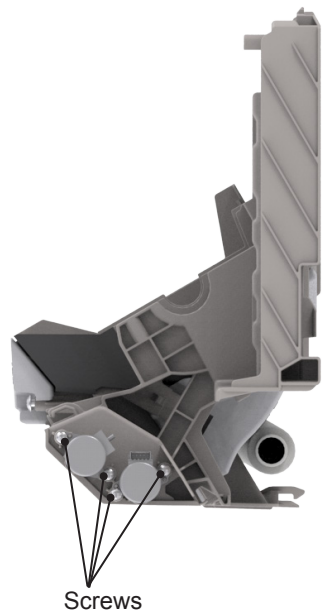
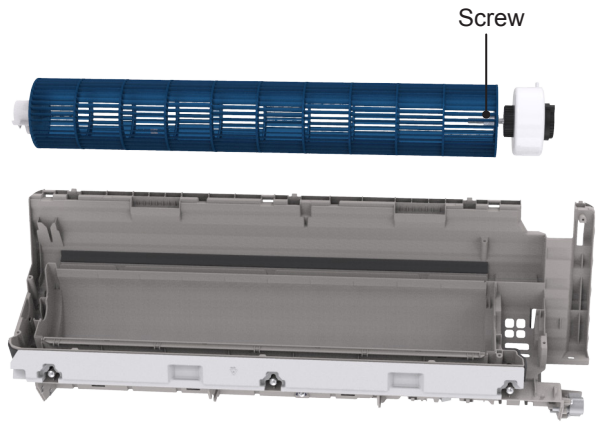

Step	Procedure
<b>8. Remove motor and cross flow fan</b>	
a	Remove the screw fixing motor clamp and then remove the motor clamp.
b	Loose the screws (2-3 circles) used for fixing the cross flow fan, pull right to pull out the motor.
<b>9. Remove swing motor</b>	
	Screw off the screws that are locking the swing motor and take the motor off.



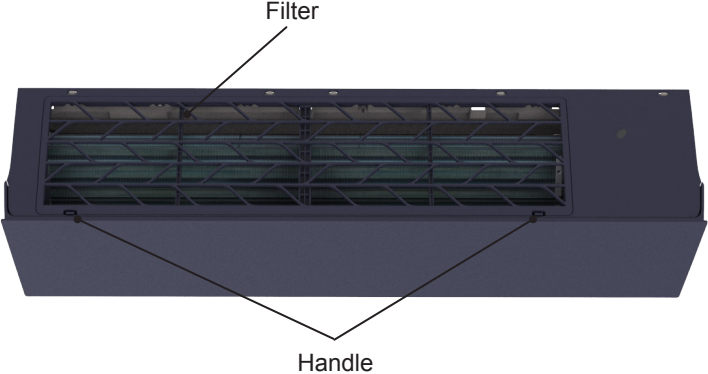
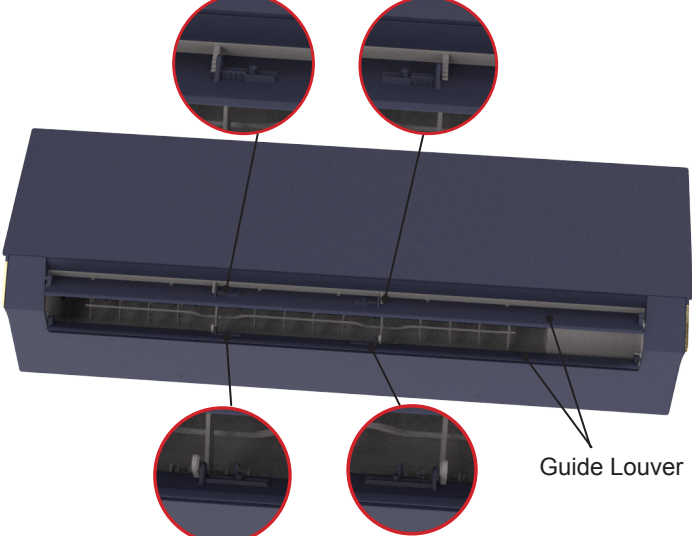

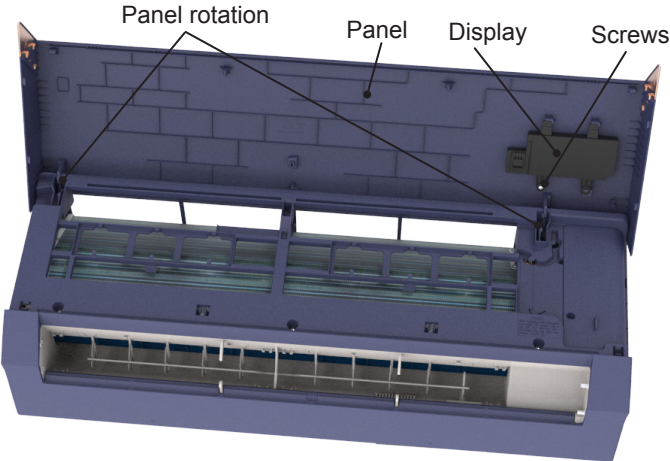
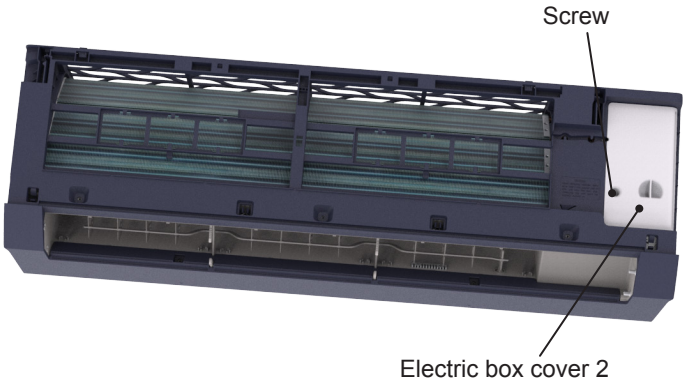
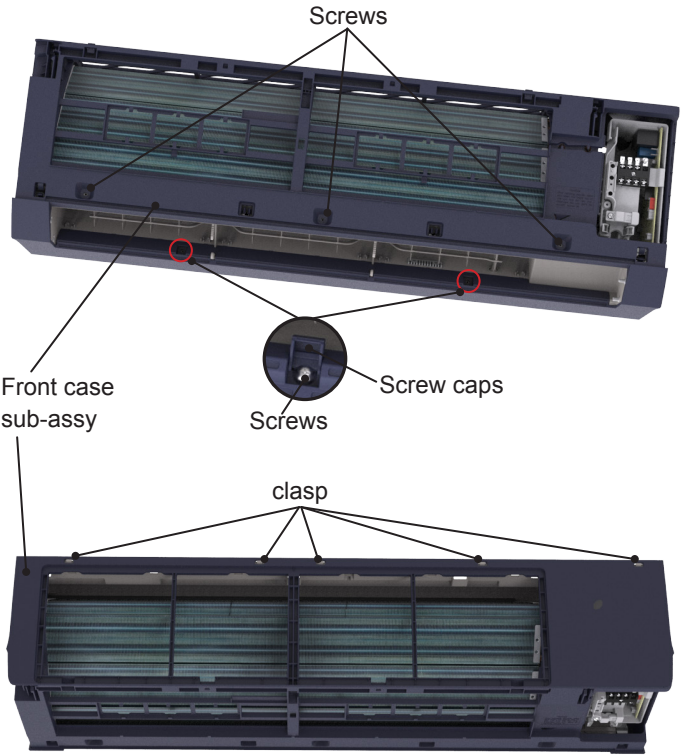
Step	Procedure
<p>Before disassemble</p>	<p>Turn off the air conditioner and disconnect the power before disassemble the air conditioner.</p> 
<p>1. Remove filter</p>	<p>Hold the handle on the filter, pull it upwards to let the clasp at the top part of the filter loose, push it forwards and then the filter can be pulled out.</p> 
<p>2.Remove upper and lower guide louver</p>	<p>Push out the plug pin on upper and lower guide louver, Bend the guide louver with hand and then separate the guide louver from the crank shaft of step motor to remove it.</p> 

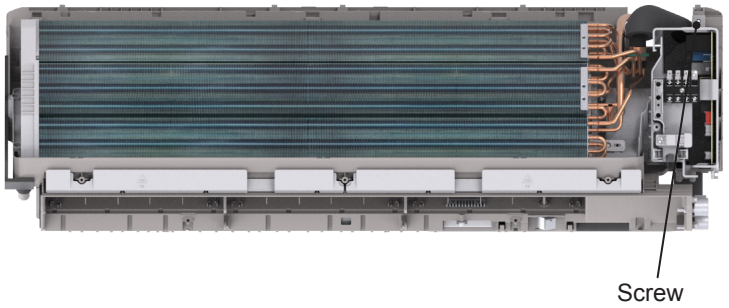
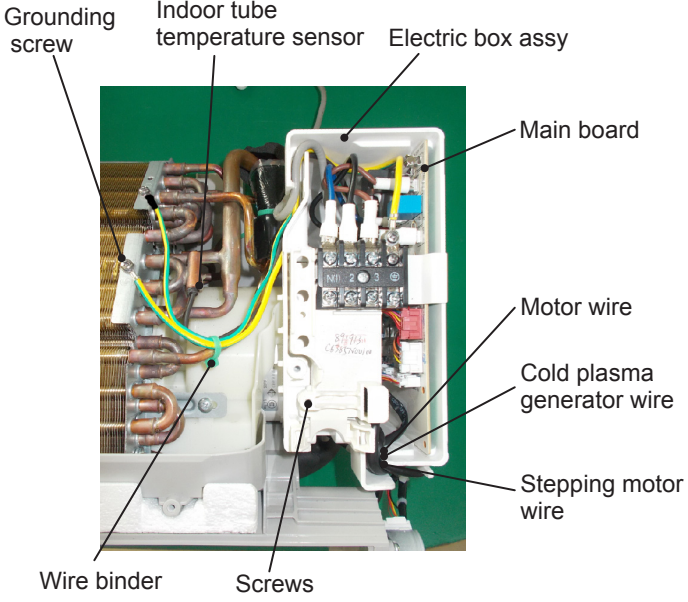
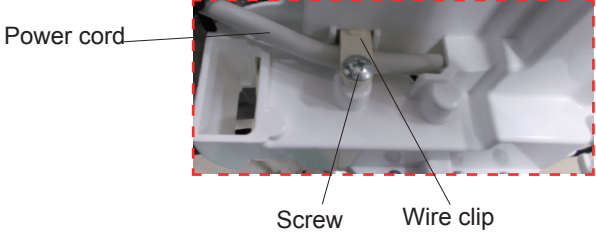
Step	Procedure
<p>3.Remove panel</p>	<p>Open the front panel; separate the panel rotation shaft from the groove fixing the front panel and then removes the front panel.</p> <p>Note: The display of some models is fixed on the panel; unscrew the screws fixing the display on the panel before removing the panel.</p> 
<p>4.Remove electric box cover 2</p>	<p>Remove the screws on the electric box cover 2 to remove the electric box cover 2.</p> 
<p>5.Remove front case sub-assy</p> <p>a</p> <p>Remove the screws fixing front case.</p> <p>Note: (1) Open the screw caps before removing the screws around the air outlet. (2) The quantity of screws fixing the front case sub-assy is different for different models.</p> <p>b</p> <p>Loosen the clasps at the top of front case. Lift the front case sub-assy upwards to remove it.</p>	

Step	Procedure
6.Remove electric box assy	
a	<p>Remove the screw fixing electric box assy.</p>  <p style="text-align: right;">Screw</p>
b	<p>① Cut off the wire binder and pull out the indoor tube temperature sensor.          ② Screw off one grounding screw.          ③ Remove the wiring terminals of motor, cold plasma generator and stepping motor.          ④ Remove the electric box assy.          ⑤ Screw off the screws that are locking each.</p>  <p>Rotate the electric box assy. Twist off the screws that are locking the wire clip and loosen the power cord. Lift up the main board and take it off.</p>
c	<p>Remove the wiring terminal of power cord. Lift up the main board and take it off.</p>  <p style="text-align: center;">Power cord      Screw      Wire clip</p> <p>Instruction:Some wiring terminal of this products is with lock catch and other devices.The pulling method is as below:          1.Remove the soft sheath for some terminals at first, hold the circlip and then pull out the terminals,          2.Pull out the holder for some terminals at first(holder is not available for some wiring terminal).hold the connector and then pull the terminal.</p>  <p style="text-align: center;">Circlip      Holder Soft sheath      Connector</p>

Step	Procedure
5.Remove panel	
a	<p>Remove 3 screws fixing evaporator assy.</p>
b	<p>At the back of the unit, Loosen the clasp of the connection pipe clamp and then remove the connection pipe clamp.</p>
c	<p>First remove the left side of evaporator from the groove of bottom shell and then remove the right side from the clasp on the bottom shell.</p>
d	<p>Adjust the position of connection pipe on evaporator slightly and then lift the evaporator upwards to remove it.</p>

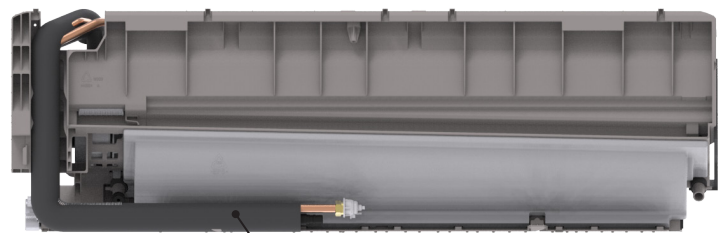
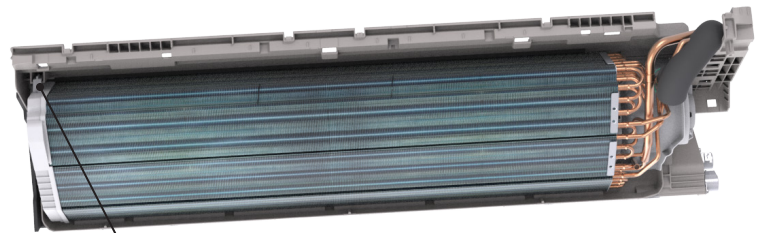
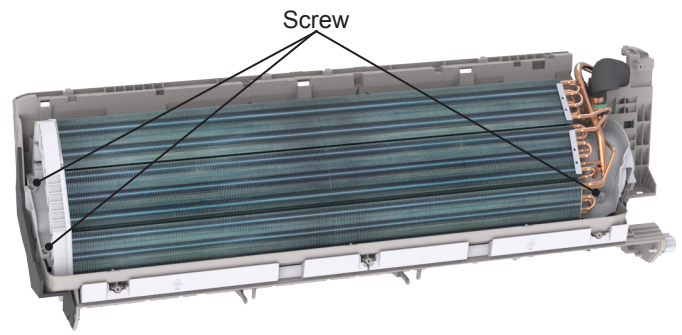

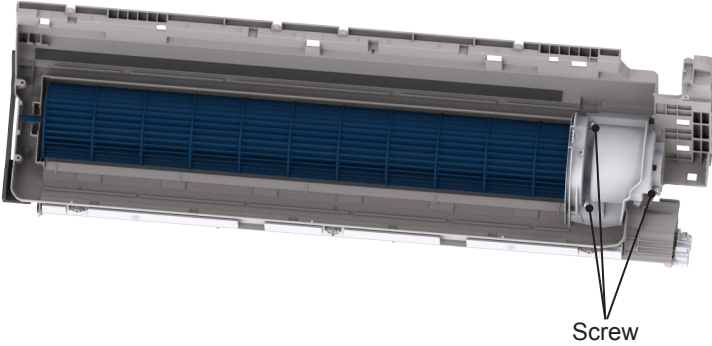
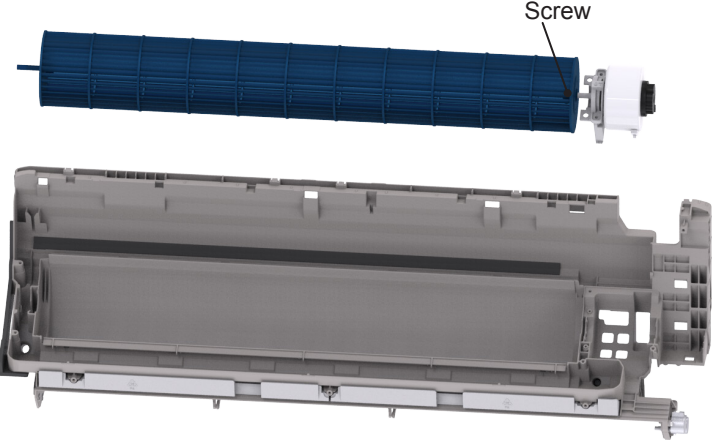
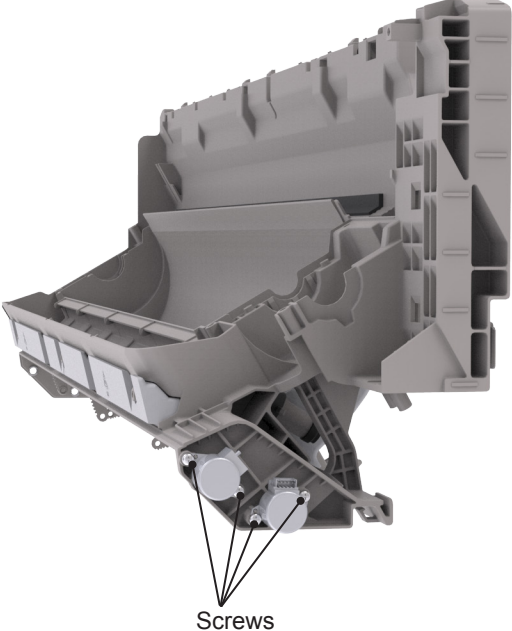

Step	Procedure
<b>8. Remove motor and cross flow fan</b>	
a	<p>Remove the screw fixing motor clamp and then remove the motor clamp.</p> 
b	<p>Loose the screws (2-3 circles) used for fixing the cross flow fan, pull right to pull out the motor.</p> 
<b>9. Remove swing motor</b>	
	<p>Screw off the screws that are locking the swing motor and take the motor off.</p> 

## 11.2 Removal Procedure of Outdoor Unit

GWH09AUCXB-K6DNA1A/O



**Caution: discharge the refrigerant completely before removal.**

Step	Procedure
<b>1. Before disassembly</b>	
<b>2. Remove big handle and valve cover</b>	<p>Remove the screws fixing big handle, valve cover and then remove them.</p> 
<b>3. Remove top cover</b>	<p>Remove the screws fixing top panel and then remove the top panel.</p> 

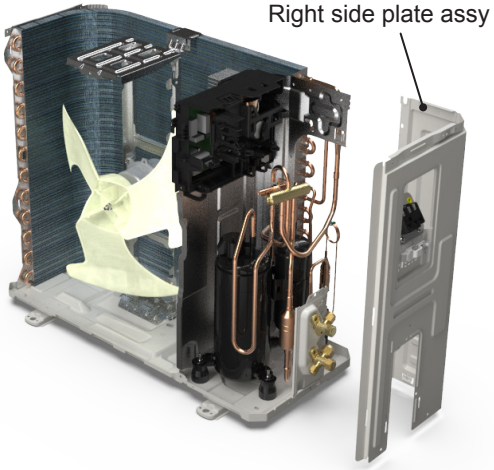
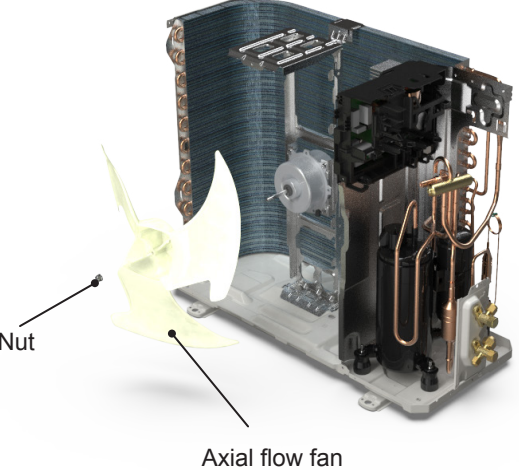

Step	Procedure
<p><b>4. Remove front panel assy</b></p>	<p>Remove connection screws connecting the front panel assy with the chassis and the motor support, and then remove the front panel assy.</p> 
<p><b>5. Remove right side plate assy</b></p>	<p>Rescrew the ground screws, remove the ground wires, loosen the screws fixing terminal board, remove the terminal board, rescrew the screws fixing the right plate, and remove the right side plate assy.</p> 
<p><b>6. Remove axial flow fan</b></p>	<p>Remove the nut on the fan and then remove the axial flow fan.</p> 

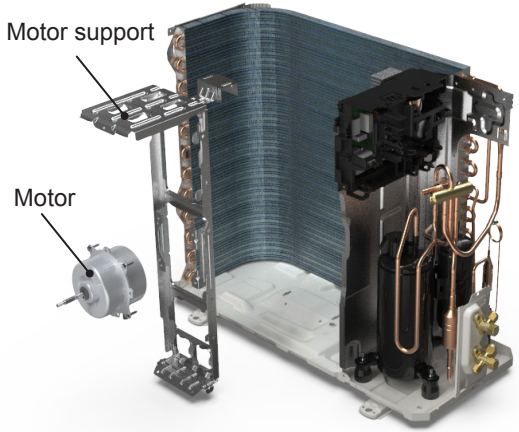
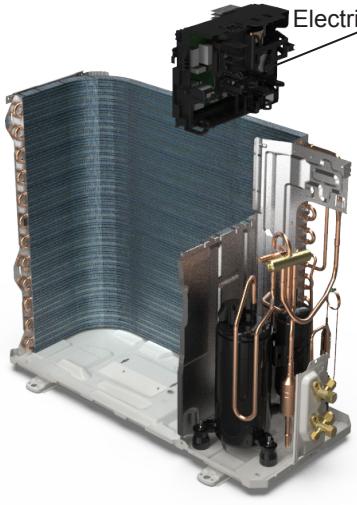
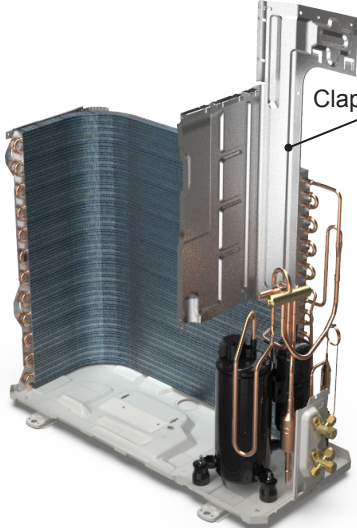

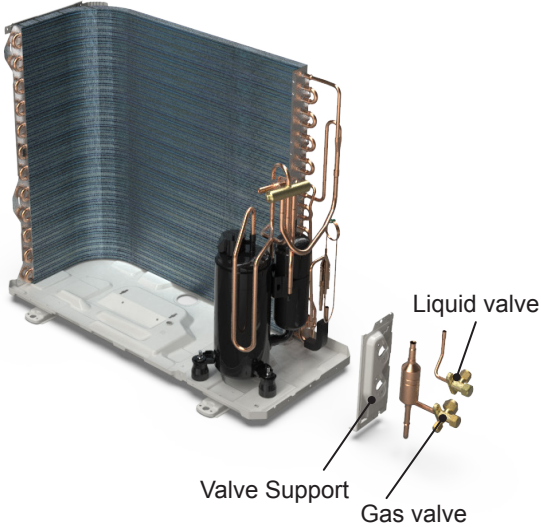
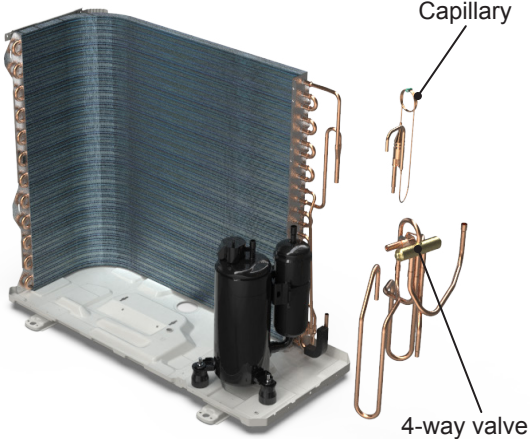
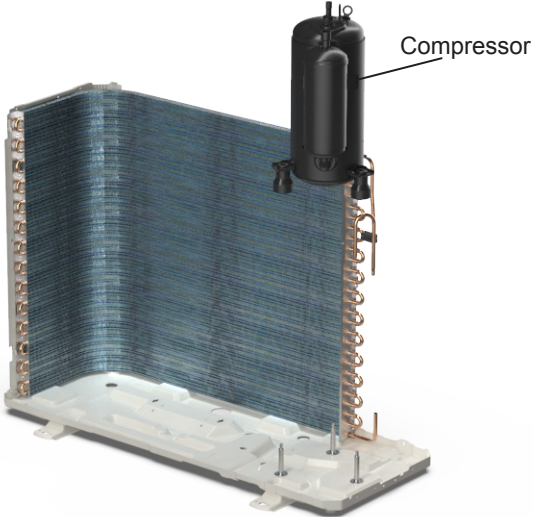

Step	Procedure
<p><b>7. Remove motor support and motor</b></p>	<p>Remove the screws fixing the motor support and lift the motor support to remove it. Remove the screws fixing the motor and then remove the motor.</p> 
<p><b>8. Remove electric box assy</b></p>	<p>Remove the terminals, lift up and rotate the electrical box assy to the right so that the snaps on the clapboard are removed and the electrical box assy are removed.</p> 
<p><b>9. Remove clapboard assy</b></p>	<p>Remove the screws fixing the clapboard assy and then remove the clapboard assy.</p> 

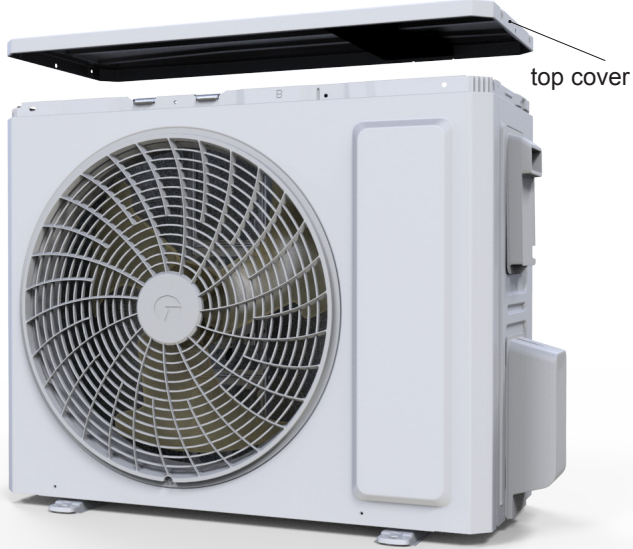
Step	Procedure
<p><b>10. Remove gas valve and liquid valve</b></p> <p>Remove the valve support block, remove the screws fixing the gas valve and the liquid valve, unsolder the welding joint connecting the gas valve and the liquid valve, remove them.</p> <p>Note: Discharge the refrigerant completely before unsoldering; when unsoldering, wrap the gas valve with a wet cloth completely to avoid damage to the valve caused by high temperature.</p>	
<p><b>11. Remove 4-way valve and capillary</b></p> <p>Unsolder the welding joints connecting capillary, and then remove it.</p> <p>Unsolder the welding joints connecting the 4-way valve assembly with capillary sub-assembly, compressor and condenser; remove the 4-way valve. Cooling only unit removes Discharge Tube and Inhalation Tube.</p> <p>Note: Before unsoldering the welding joint, wrap the 4-way valve with a wet cloth completely to avoid damage to the valve caused by high temperature.</p>	
<p><b>12. Remove compressor</b></p> <p>Remove the 3 foot nuts on the compressor and then remove the compressor.</p>	

 **Caution: discharge the refrigerant completely before removal.**

Step	Procedure
<p><b>1. Before disassembly</b></p>	
<p><b>2. Remove top cover</b></p>	<p>Remove the screws fixing top panel and then remove the top panel.</p> 
<p><b>3. Remove big handle and valve cover</b></p>	<p>Remove the screws fixing big handle, valve cover and then remove them.</p> 

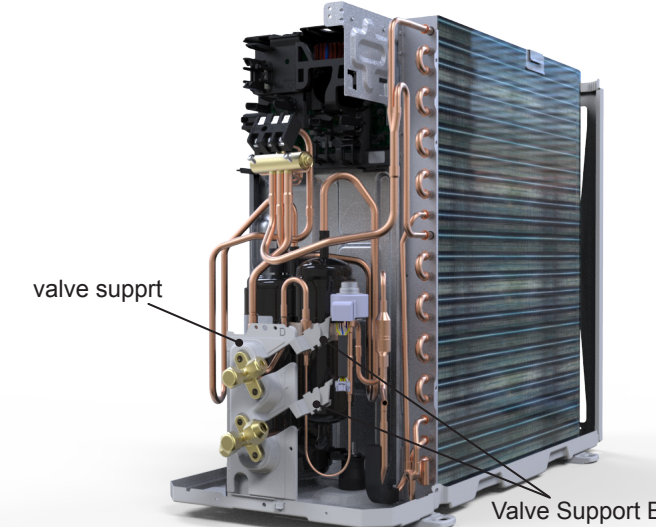
Step	Procedure
<p><b>4. Remove front panel assy</b></p>	<p>Remove connection screws connecting the front panel assy with the chassis and the motor support, and then remove the front panel assy.</p> 
<p><b>5. Remove right side plate assy</b></p>	<p>Rescrew the ground screws, remove the ground wires, loosen the screws fixing terminal board, remove the terminal board, rescrew the screws fixing the right plate, and remove the right side plate assy.</p> 
<p><b>6. Remove valve support</b></p>	<p>Remove the valve support block, remove the screws fixing valve support, remove the screws fixing the liquid valve and gas valve then remove the valve support.</p> 

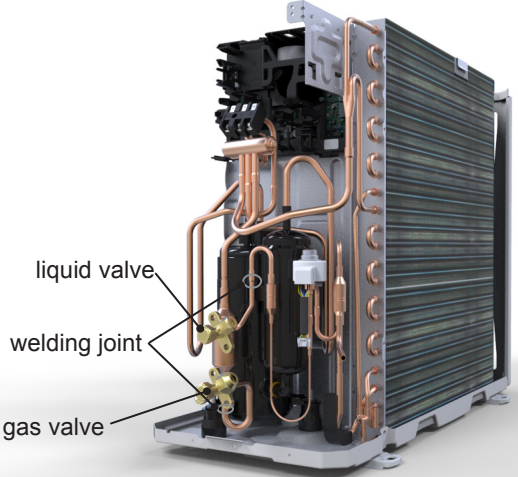
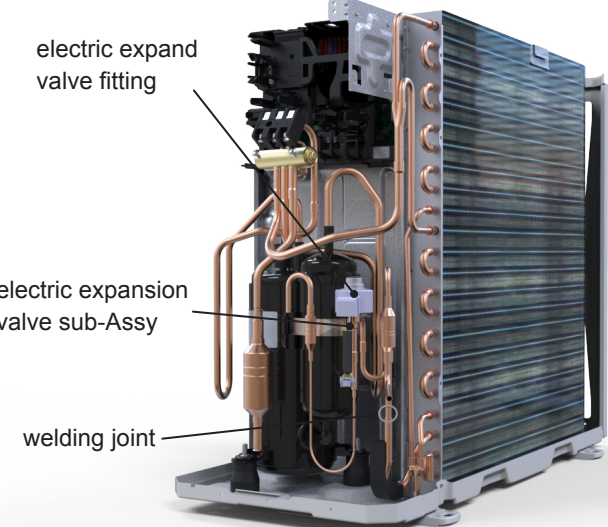
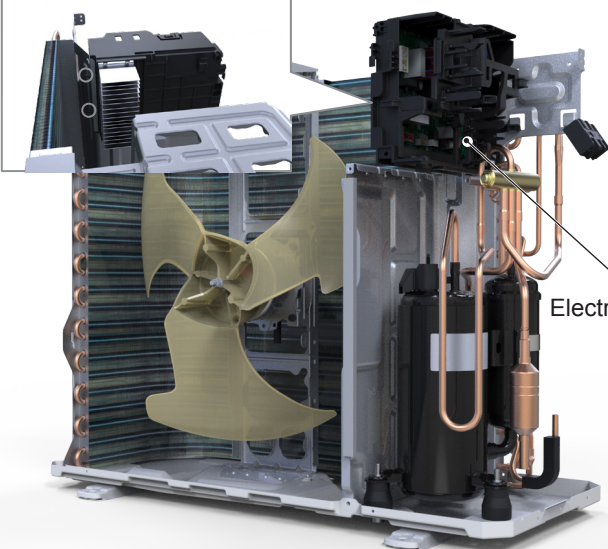
Step	Procedure
<p><b>7. Remove gas valve and liquid valve</b></p> <p>Unsolder the welding joint connecting the gas valve and the liquid valve, remove them.</p> <p>Note: Discharge the refrigerant completely before unsoldering; when unsoldering, wrap the gas valve with a wet cloth completely to avoid damage to the valve caused by high temperature.</p>	 <p>liquid valve</p> <p>welding joint</p> <p>gas valve</p>
<p><b>8. Remove electronic expansion valve</b></p> <p>Remove the terminals of the electronic expansion valve coil and rotate to remove the electronic expansion valve coil.</p> <p>Unsolder the welding joint connecting the electronic expansion Valve and then remove the electronic expansion valve.</p>	 <p>electric expand valve fitting</p> <p>electric expansion valve sub-Assy</p> <p>welding joint</p>
<p><b>9. Remove electric box assy</b></p> <p>Unplug the terminals, unscrew 1 screw that secures the electrical box assy, release the two snaps on the electrical box assy (in the clapboard and condenser angle), pull outwards, and remove the electrical box assy.</p>	 <p>Electric Box Assy</p>

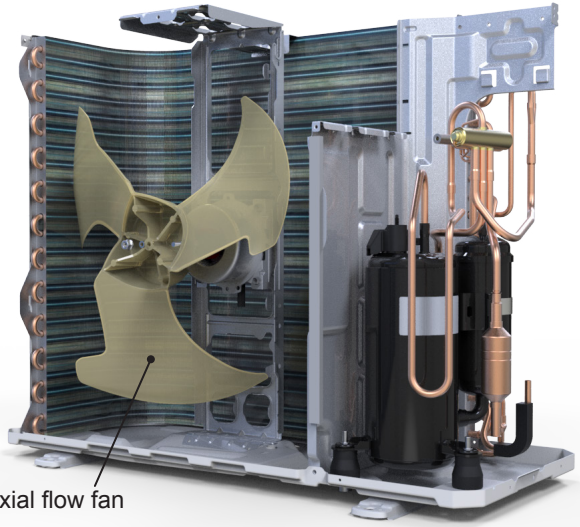
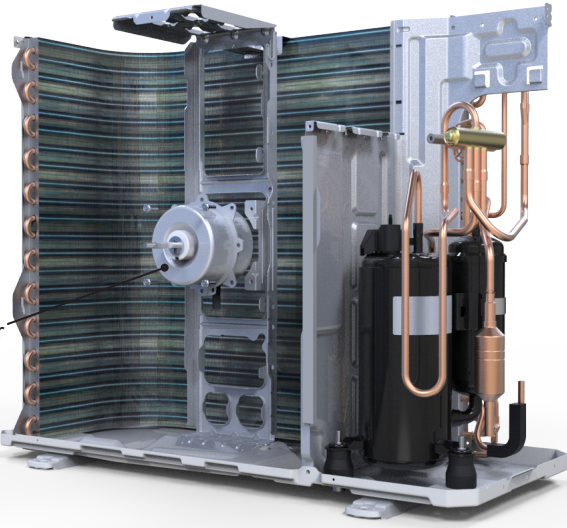
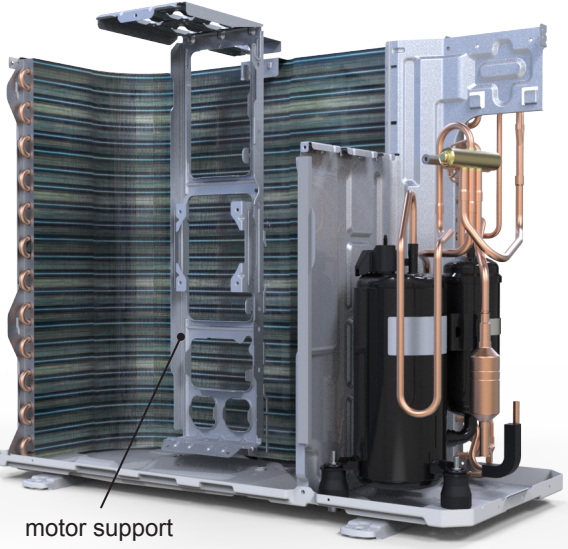
Step	Procedure
<p><b>10. Remove axial flow fan</b></p>	<p>Remove the nut on the fan and then remove the axial flow fan.</p> 
<p><b>11. Remove motor</b></p>	<p>Remove the screws fixing the motor and then remove the motor.</p> 
<p><b>12. Remove motor support</b></p>	<p>Remove the screws fixing the motor support and lift the motor support to remove it.</p> 

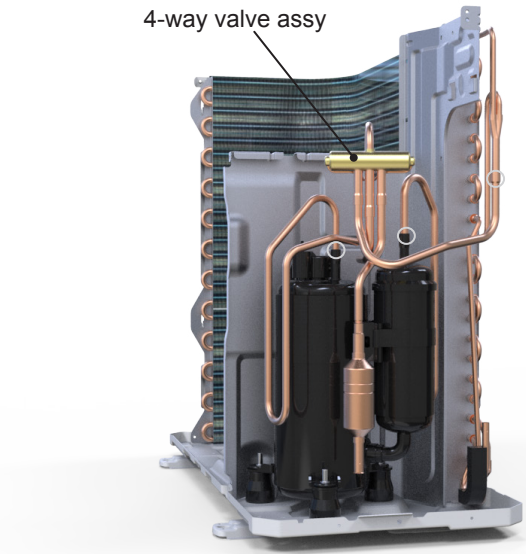
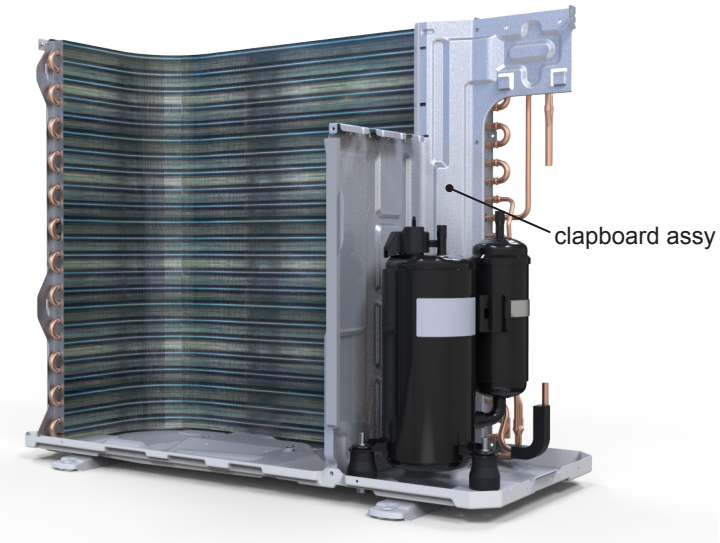
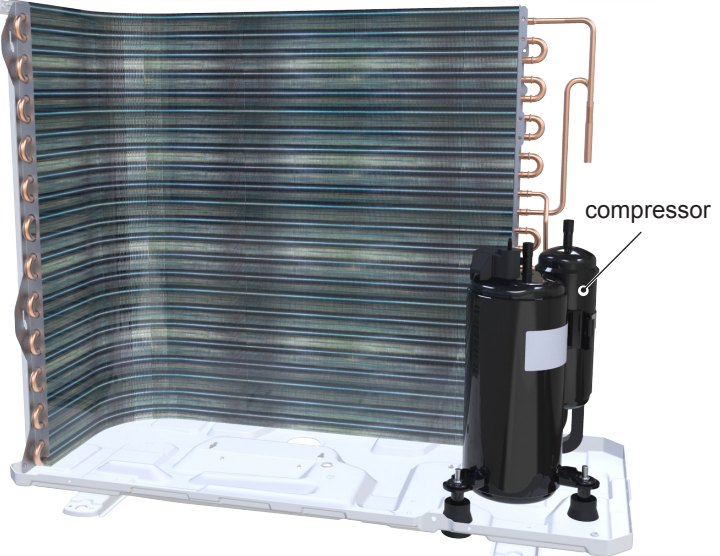

Step	Procedure
<p><b>13. Remove 4-way valve assy</b></p>	<p>Unsolder the welding joints connecting the 4-way valve assy, remove the 4-way valve.</p> <p>Note: Before unsoldering the welding joint, wrap the 4-way valve with a wet cloth completely to avoid damage to the valve caused by high temperature.</p> 
<p><b>14. Remove clapboard assy</b></p>	<p>Remove the screws fixing the clapboard assy and then remove the clapboard assy.</p> 
<p><b>15. Remove compressor</b></p>	<p>Remove the 3 foot nuts on the compressor and then remove the compressor.</p> 



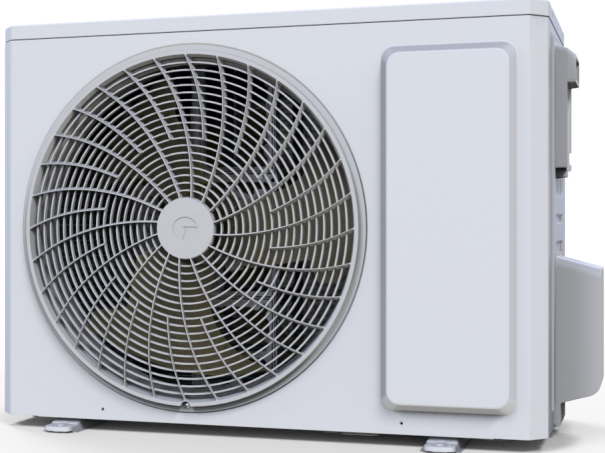
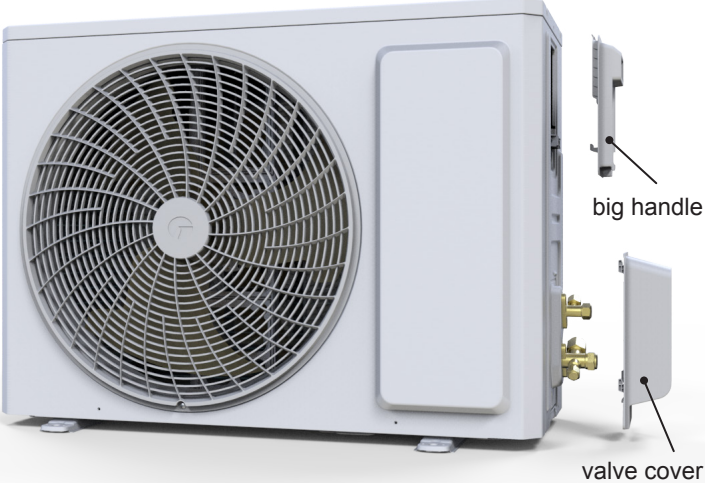
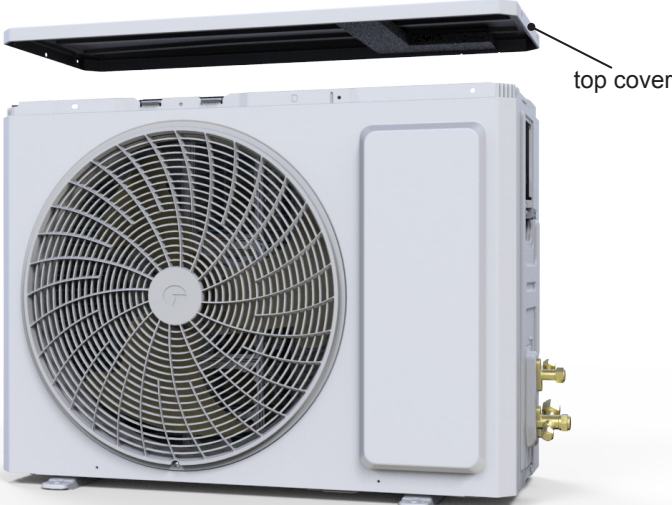

**Caution: discharge the refrigerant completely before removal.**

Step	Procedure
<b>1. Before disassembly</b>	
<b>2. Remove big handle and valve cover</b>	<p data-bbox="191 1144 786 1209">Remove the screws fixing big handle, valve cover and then remove them.</p> 
<b>3. Remove top cover</b>	<p data-bbox="191 1727 786 1793">Remove the screws fixing top panel and then remove the top panel.</p> 

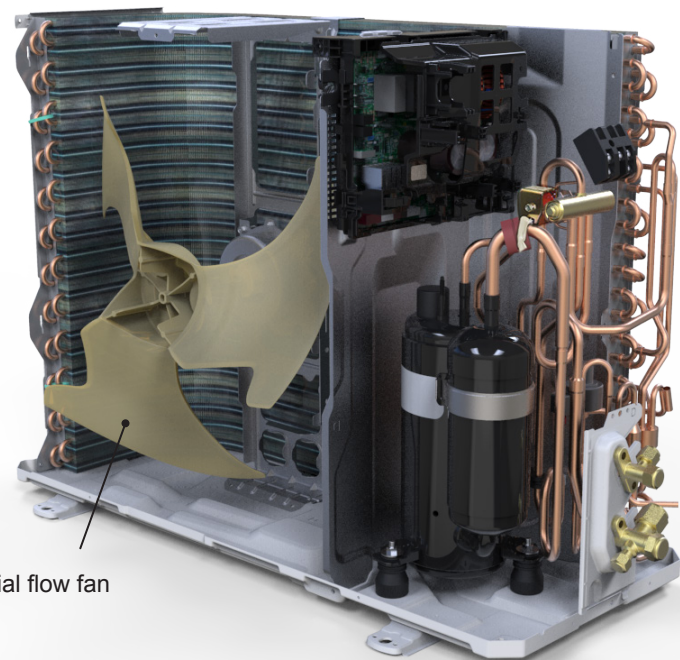

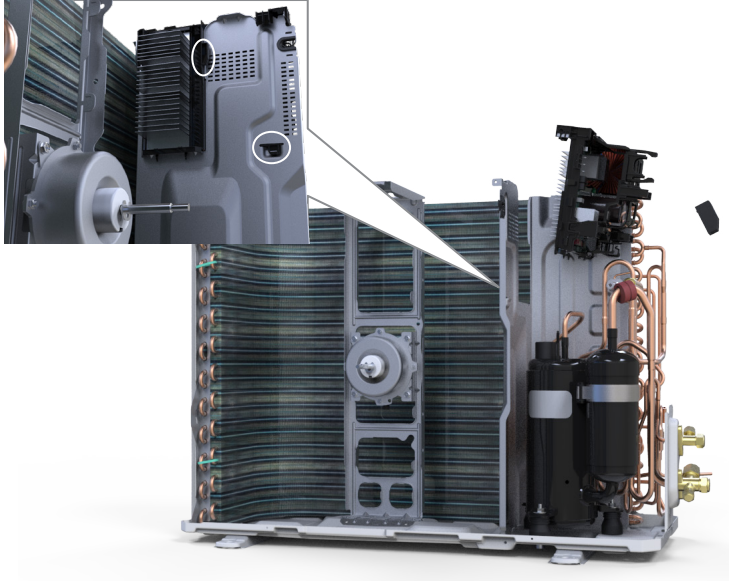
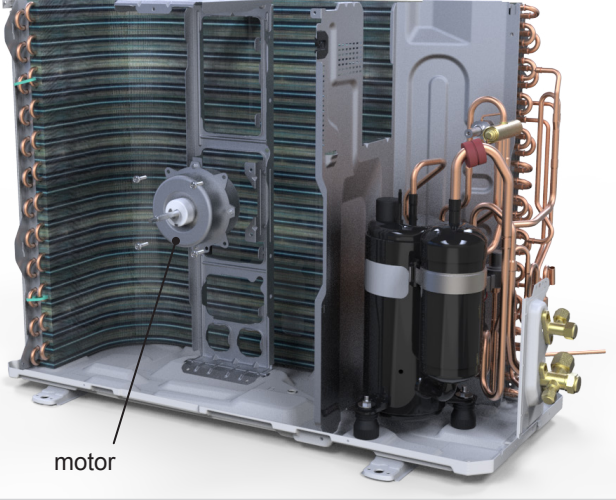
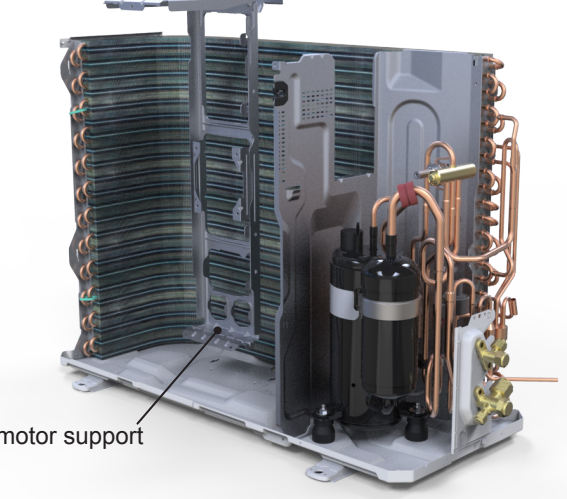
Step	Procedure
<p><b>4. Remove front panel assy</b></p> <p>Remove connection screws connecting the front panel assy with the chassis and the motor support, and then remove the front panel assy.</p>	 <p>front panel</p>
<p><b>5. Remove right side plate assy</b></p> <p>Rescrew the ground screws, remove the ground wires, loosen the screws fixing terminal board, remove the terminal board, rescrew the screws fixing the right plate, and remove the right side plate assy.</p>	 <p>right side plate</p>
<p><b>6. Remove axial flow fan</b></p> <p>Remove the nut on the fan and then remove the axial flow fan.</p>	 <p>axial flow fan</p>

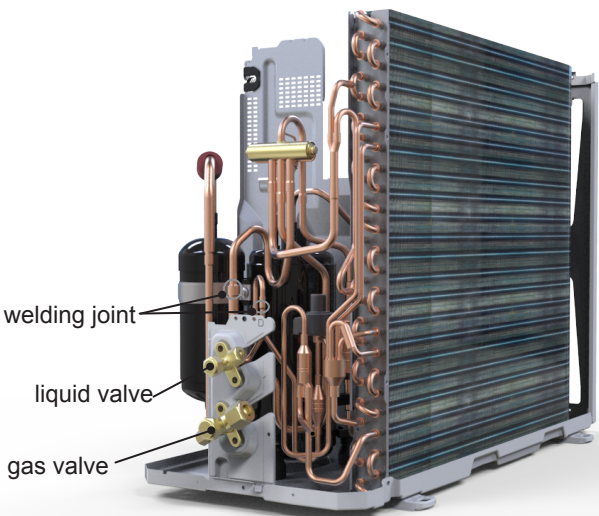

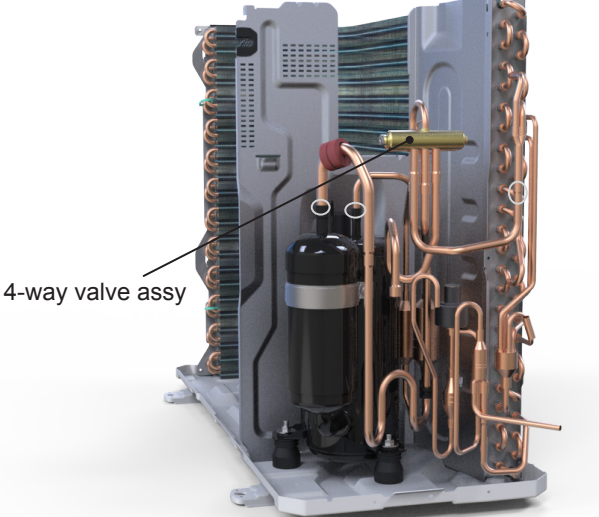
Step	Procedure
<p><b>7. Remove electric box assy</b></p>	<p>Remove the terminals, lift up and rotate the electrical box assy to the right so that the snaps on the clapboard are removed and the electrical box assy are removed.</p> 
<p><b>8. Remove motor</b></p>	<p>Remove the screws fixing the motor and then remove the motor.</p> 
<p><b>9. Remove motor support</b></p>	<p>Remove the screws fixing the motor support and lift the motor support to remove it.</p> 

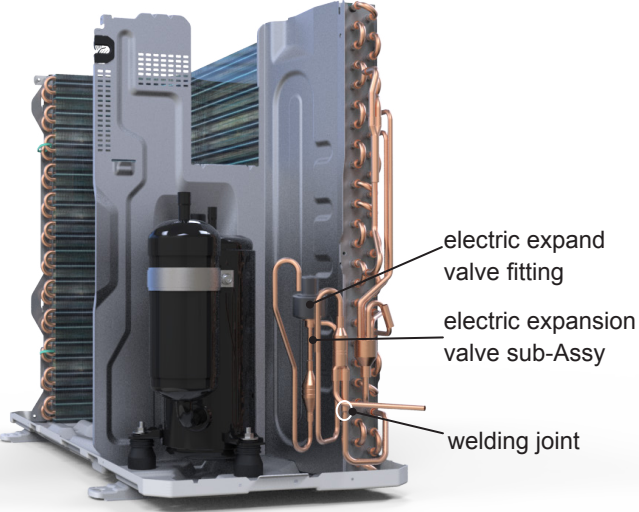
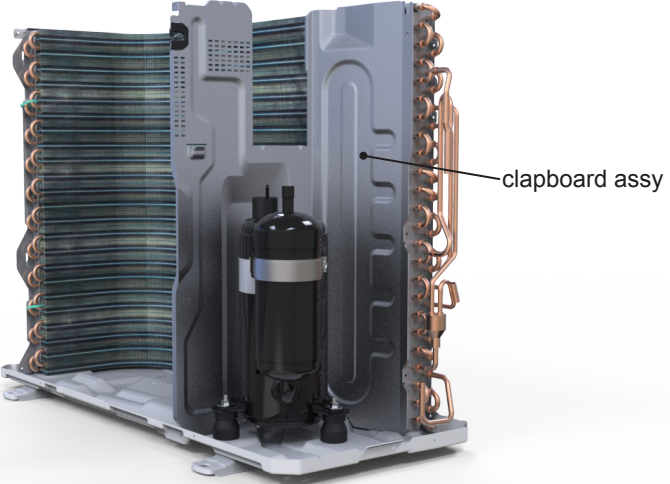
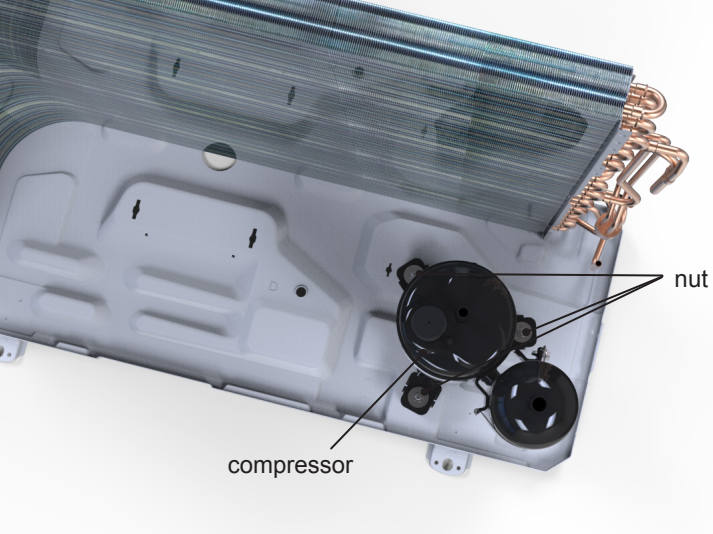
Step	Procedure
<p><b>10. Remove gas valve and liquid valve</b></p> <p>Remove the valve support block, remove the screws fixing the gas valve and the liquid valve, unsolder the welding joint connecting the gas valve and the liquid valve, remove them.</p> <p>Note: Discharge the refrigerant completely before unsoldering; when unsoldering, wrap the gas valve with a wet cloth completely to avoid damage to the valve caused by high temperature.</p>	 <p>The diagram shows a side view of a compressor unit with its copper piping and valves. Three labels with leader lines point to specific components: 'welding joint' at the top of the valve assembly, 'liquid valve' in the middle, and 'gas valve' at the bottom.</p>
<p><b>11. Remove valve support</b></p> <p>Remove the screws fixing valve support, then remove the valve support.</p>	 <p>The diagram shows the same compressor unit from a similar perspective. A label 'valve support' with a leader line points to the metal bracket that holds the valves in place.</p>
<p><b>12. Remove 4-way valve assy</b></p> <p>Unsolder the welding joints connecting the 4-way valve assy, remove the 4-way valve.</p> <p>Note: Before unsoldering the welding joint, wrap the 4-way valve with a wet cloth completely to avoid damage to the valve caused by high temperature.</p>	 <p>The diagram shows the compressor unit with the 4-way valve assembly highlighted. A label '4-way valve assy' with a leader line points to the central valve component where the four refrigerant lines meet.</p>



Step	Procedure
<p><b>13. Remove electronic expansion valve</b></p>	<p>Remove the terminals of the electric expand valve fitting and rotate to remove the electric expand valve fitting.</p> <p>Unsolder the welding joint connecting the electronic expansion Valve and then remove the electronic expansion valve.</p> 
<p><b>14. Remove clapboard assy</b></p>	<p>Remove the screws fixing the clapboard assy and then remove the clapboard assy.</p> 
<p><b>15. Remove compressor</b></p>	<p>Remove the 3 foot nuts on the compressor and then remove the compressor.</p> 

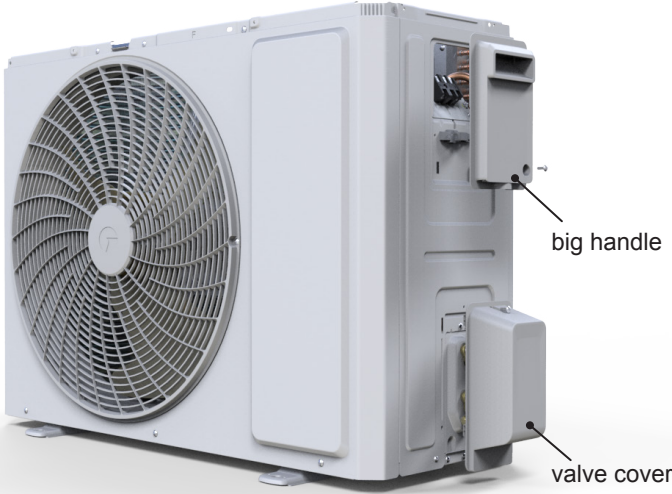

**Caution: discharge the refrigerant completely before removal.**

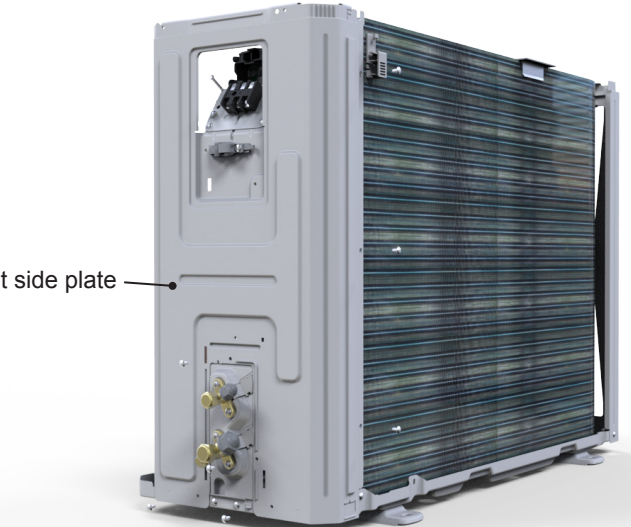
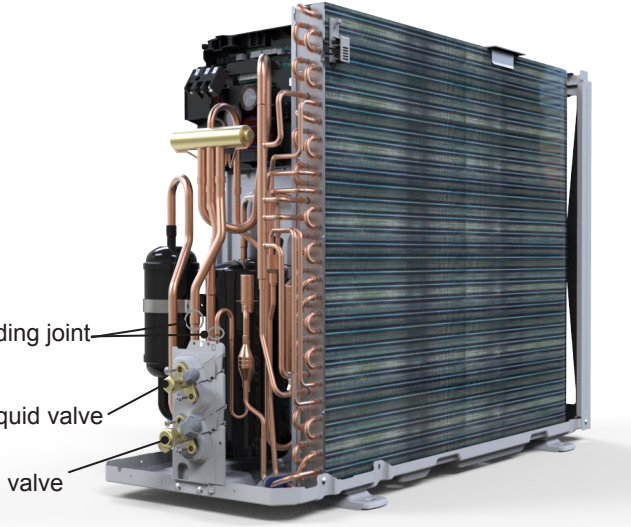

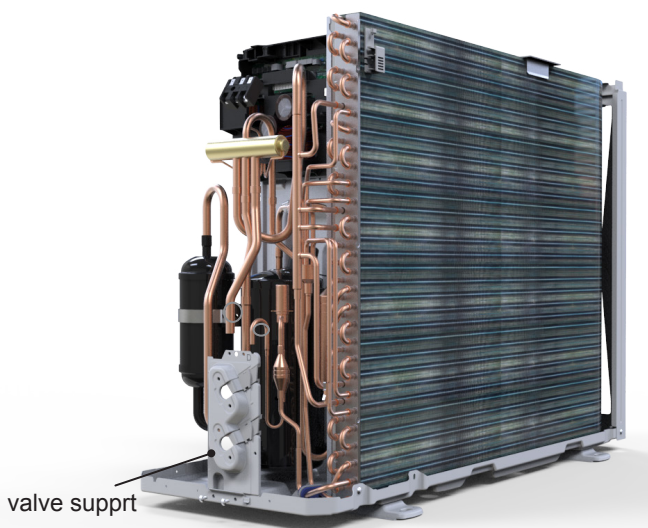
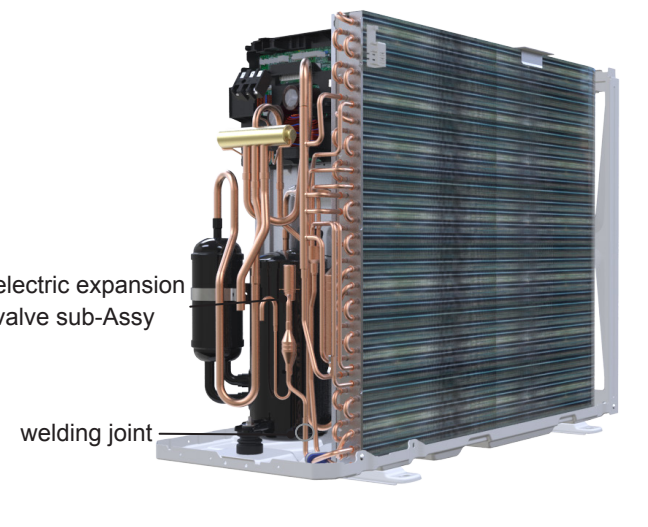
Step	Procedure
<p><b>1. Before disassembly</b></p>	
<p><b>2. Remove top cover</b></p>	<p>Remove the screws fixing top panel and then remove the top panel.</p> 
<p><b>3. Remove big handle and valve cover</b></p>	<p>Remove the screws fixing big handle, valve cover and then remove them.</p> 

Step	Procedure
<p><b>4. Remove front panel assy</b></p>	<p>Remove connection screws connecting the front panel assy with the chassis and the motor support, and then remove the front panel assy.</p> 
<p><b>5. Remove right side plate assy</b></p>	<p>Rescrew the ground screws, remove the ground wires, loosen the screws fixing terminal board, remove the terminal board, rescrew the screws fixing the right plate, and remove the right side plate assy.</p> 
<p><b>6. Remove gas valve and liquid valve</b></p>	<p>Remove the valve support block, remove the screws fixing the gas valve and the liquid valve, unsolder the welding joint connecting the gas valve and the liquid valve, remove them.</p> <p>Note: Discharge the refrigerant completely before unsoldering; when unsoldering, wrap the gas valve with a wet cloth completely to avoid damage to the valve caused by high temperature.</p> 

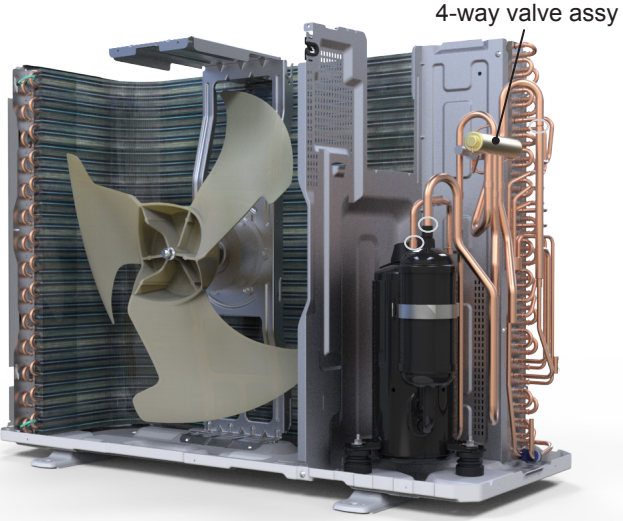
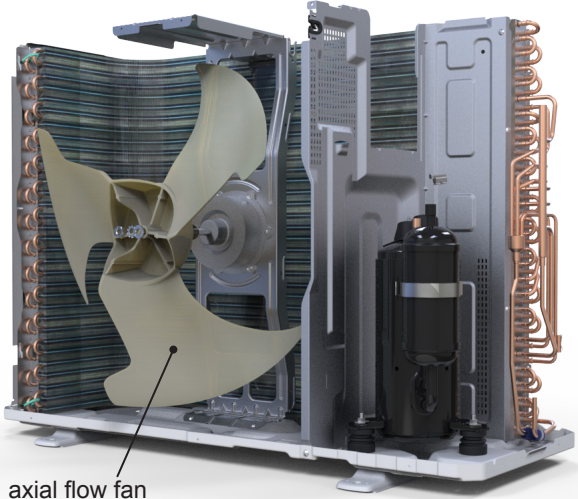
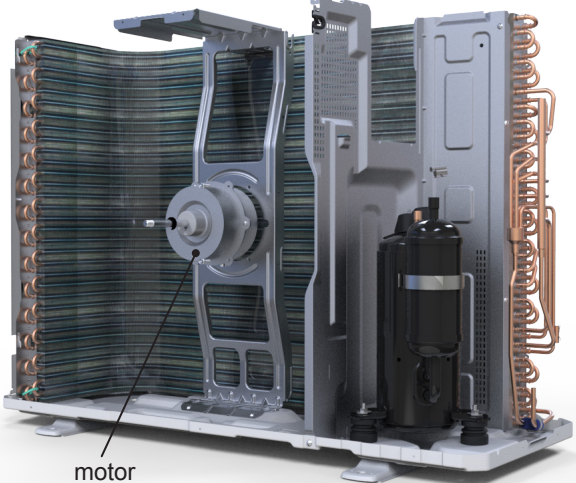
Step	Procedure
<p><b>7. Remove valve support</b></p>	<p>Remove the screws fixing valve support, then remove the valve support.</p>  <p>valve support</p>
<p><b>8. Remove electronic expansion valve</b></p>	<p>Remove the terminals of the electronic expansion valve coil and rotate to remove the electronic expansion valve coil.          Unsolder the welding joint connecting the electronic expansion Valve and then remove the electronic expansion valve.</p>  <p>electric expansion valve sub-Assy</p> <p>welding joint</p>
<p><b>9. Remove electric box assy</b></p>	<p>Remove the terminals, lift up and rotate the electrical box assy to the right so that the snaps on the clapboard are removed and the electrical box assy are removed.</p> 

Step	Procedure
<p><b>10. Remove 4-way valve assy</b></p>	<p>Unsolder the welding joints connecting the 4-way valve assy, remove the 4-way valve.</p> <p>Note: Before unsoldering the welding joint, wrap the 4-way valve with a wet cloth completely to avoid damage to the valve caused by high temperature.</p> 
<p><b>11. Remove axial flow fan</b></p>	<p>Remove the nut on the fan and then remove the axial flow fan.</p> 
<p><b>12. Remove motor</b></p>	<p>Remove the screws fixing the motor and then remove the motor.</p> 

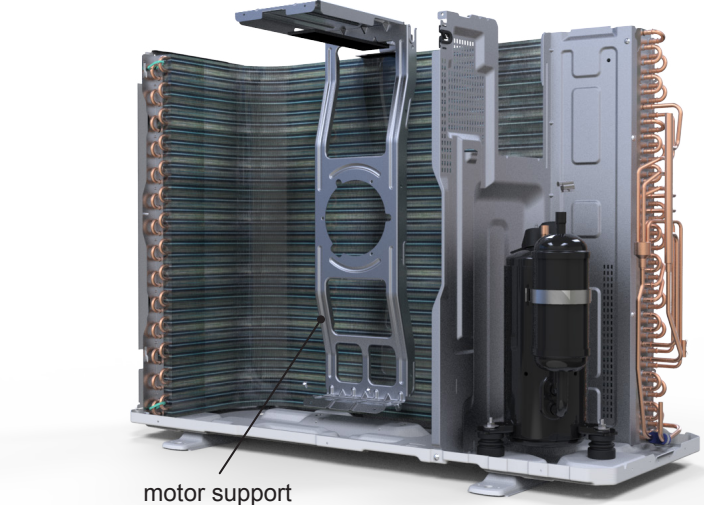

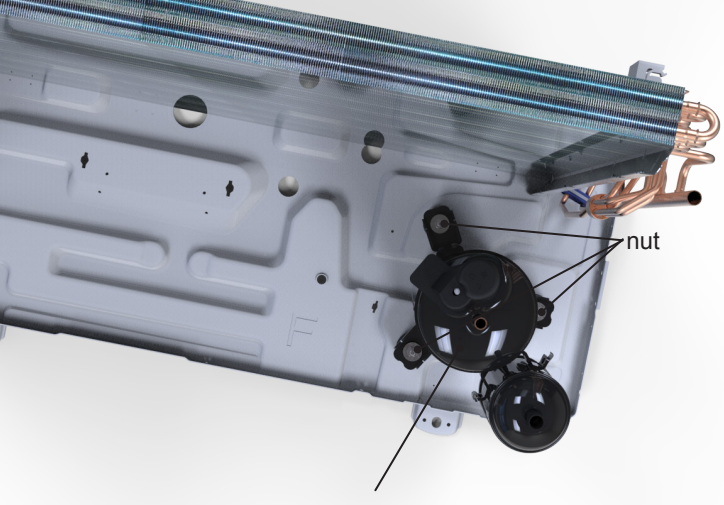
Step	Procedure
<p><b>12. Remove motor support</b></p>	<p>Remove the screws fixing the motor support and lift the motor support to remove it.</p> 
<p><b>14. Remove clapboard assy</b></p>	<p>Remove the screws fixing the clapboard assy and then remove the clapboard assy.</p> 
<p><b>15. Remove compressor</b></p>	<p>Remove the 3 foot nuts on the compressor and then remove the compressor.</p> 

# Appendix

## Appendix 1: Reference Sheet of Celsius and Fahrenheit

Conversion formula for Fahrenheit degree and Celsius degree:  $T_f = T_c \times 1.8 + 32$

### Set temperature

Fahrenheit display temperature (°F)	Fahrenheit (°F)	Celsius (°C)	Fahrenheit display temperature (°F)	Fahrenheit (°F)	Celsius (°C)	Fahrenheit display temperature (°F)	Fahrenheit (°F)	Celsius (°C)
61	60.8	16	69/70	69.8	21	78/79	78.8	26
62/63	62.6	17	71/72	71.6	22	80/81	80.6	27
64/65	64.4	18	73/74	73.4	23	82/83	82.4	28
66/67	66.2	19	75/76	75.2	24	84/85	84.2	29
68	68	20	77	77	25	86	86	30

### Ambient temperature

Fahrenheit display temperature (°F)	Fahrenheit (°F)	Celsius (°C)	Fahrenheit display temperature (°F)	Fahrenheit (°F)	Celsius (°C)	Fahrenheit display temperature (°F)	Fahrenheit (°F)	Celsius (°C)
32/33	32	0	55/56	55.4	13	79/80	78.8	26
34/35	33.8	1	57/58	57.2	14	81	80.6	27
36	35.6	2	59/60	59	15	82/83	82.4	28
37/38	37.4	3	61/62	60.8	16	84/85	84.2	29
39/40	39.2	4	63	62.6	17	86/87	86	30
41/42	41	5	64/65	64.4	18	88/89	87.8	31
43/44	42.8	6	66/67	66.2	19	90	89.6	32
45	44.6	7	68/69	68	20	91/92	91.4	33
46/47	46.4	8	70/71	69.8	21	93/94	93.2	34
48/49	48.2	9	72	71.6	22	95/96	95	35
50/51	50	10	73/74	73.4	23	97/98	96.8	36
52/53	51.8	11	75/76	75.2	24	99	98.6	37
54	53.6	12	77/78	77	25			

## Appendix 2: Configuration of Connection Pipe

- Standard length of connection pipe (More details please refer to the specifications.)
- Min length of connection pipe for the unit with standard connection pipe of 5m, there is no limitation for the min length of connection pipe. For the unit with standard connection pipe of 7.5m and 8m, the min length of connection pipe is 3m.
- Max. length of connection pipe and max. high difference. (More details please refer to the specifications.)
- The additional refrigerant oil and refrigerant charging required after prolonging connection pipe
  - After the length of connection pipe is prolonged for 10m at the basis of standard length, you should add 5ml of refrigerant oil for each additional 5m of connection pipe.
  - The calculation method of additional refrigerant charging amount (on the basis of liquid pipe):
  - Basing on the length of standard pipe, add refrigerant according to the requirement as shown in the table. The additional refrigerant charging amount per meter is different according to the diameter of liquid pipe. See the following sheet.
  - Additional refrigerant charging amount = prolonged length of liquid pipe X additional refrigerant charging amount per meter

Additional refrigerant charging amount for R32

Piping size		Indoor unit throttle	Outdoor unit throttle	
Liquid pipe	Gas pipe	Cooling only, cooling and heating (g / m)	Cooling only(g/m)	Cooling and heating(g/m)
1/4"	3/8" or 1/2"	14	12	16
1/4" or 3/8"	5/8" or 3/4"	40	12	40
1/2"	3/4" or 7/8"	80	24	96
5/8"	1" or 1 1/4"	136	48	96
3/4"	/	200	200	200
7/8"	/	280	280	280

## Appendix 3: Pipe Expanding Method

### ⚠ Note:

Improper pipe expanding is the main cause of refrigerant leakage. Please expand the pipe according to the following steps:

#### A: Cut the pipe

- Confirm the pipe length according to the distance of indoor unit and outdoor unit.
- Cut the required pipe with pipe cutter.

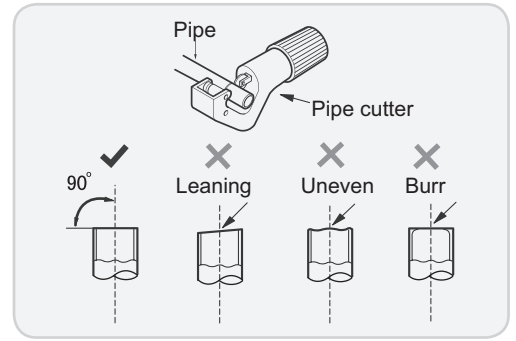

#### B: Remove the burrs

- Remove the burrs with shaper and prevent the burrs from getting into the pipe.

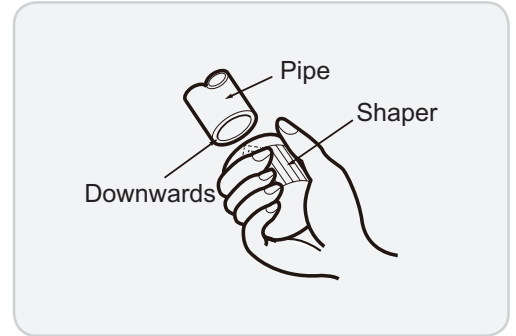

#### C: Put on suitable insulating pipe.

#### D: Put on the union nut

- Remove the union nut on the indoor connection pipe and outdoor valve; install the union nut on the pipe.

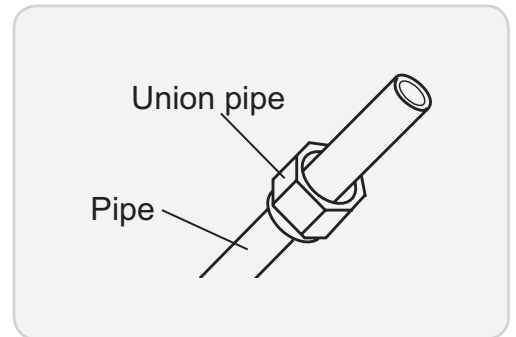

#### E: Expand the port

- Expand the port with expander.

### ⚠ Note:

- "A" is different according to the diameter, please refer to the sheet below:

Outer diameter(mm)	A(mm)	
	Max	Min
Φ6 - 6.35 (1/4")	1.3	0.7
Φ9 - Φ9.52 (3/8")	1.6	1.0
Φ12 - 12.70 (1/2")	1.8	1.0
Φ16 - 15.88 (5/8")	2.4	2.2

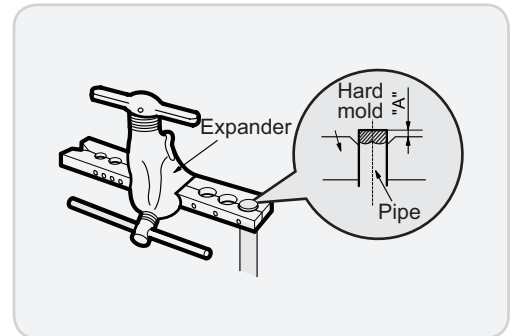

#### F: Inspection

- Check the quality of expanding port. If there is any blemish, expand the port again according to the steps above.

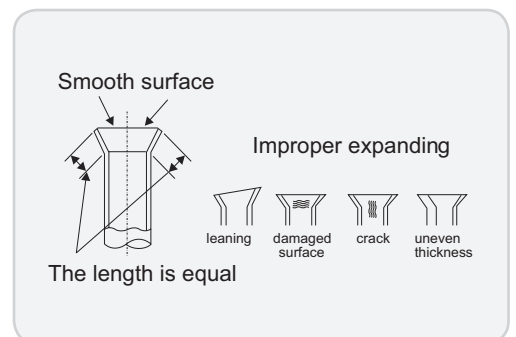

## Appendix 4: List of Resistance for Temperature Sensor

### Resistance Table of Ambient Temperature Sensor for Indoor and Outdoor Units(15K)

Temp(°C)	Resistance(kΩ)
-19	138.10
-18	128.60
-16	115.00
-14	102.90
-12	92.22
-10	82.75
-8	74.35
-6	66.88
-4	60.23
-2	54.31

Temp(°C)	Resistance(kΩ)
0	49.02
2	44.31
4	40.09
6	36.32
8	32.94
10	29.90
12	27.18
14	24.73
16	22.53
18	20.54

Temp(°C)	Resistance(kΩ)
20	18.75
22	17.14
24	15.68
26	14.36
28	13.16
30	12.07
32	11.09
34	10.20
36	9.38
38	8.64

Temp(°C)	Resistance(kΩ)
40	7.97
42	7.35
44	6.79
46	6.28
48	5.81
50	5.38
52	4.99
54	4.63
56	4.29
58	3.99

### Resistance Table of Tube Temperature Sensors for Indoor and Outdoor (20K)

Temp(°C)	Resistance(kΩ)
-19	181.40
-15	145.00
-10	110.30
-5	84.61
0	65.37
5	50.87
10	39.87
15	31.47

Temp(°C)	Resistance(kΩ)
20	25.01
25	20.00
30	16.10
35	13.04
40	10.62
45	8.71
50	7.17
55	5.94

Temp(°C)	Resistance(kΩ)
60	4.95
65	4.14
70	3.48
75	2.94
80	2.50
85	2.13
90	1.82
95	1.56

Temp(°C)	Resistance(kΩ)
100	1.35
105	1.16
110	1.01
115	0.88
120	0.77
125	0.67
130	0.59
135	0.52

### Resistance Table of Discharge Temperature Sensor for Outdoor(50K)

Temp(°C)	Resistance(kΩ)
-30	911.400
-25	660.8
-20	486.5
-15	362.9
-10	274
-5	209
0	161
5	125.1

Temp(°C)	Resistance(kΩ)
10	98
15	77.35
20	61.48
25	49.19
30	39.61
35	32.09
40	26.15
45	21.43

Temp(°C)	Resistance(kΩ)
50	17.65
55	14.62
60	12.17
65	10.18
70	8.555
75	7.224
80	6.129
85	5.222

Temp(°C)	Resistance(kΩ)
90	4.469
95	3.841
100	3.315
105	2.872
110	2.498
115	2.182
120	1.912
125	1.682

JF00305011



GREE ELECTRIC APPLIANCES, INC. OF ZHUHAI

Add: West Jinji Rd, Qianshan, Zhuhai, Guangdong, China, 519070

Tel: (+86-756) 8522219

Fax: (+86-756) 8669426

E-mail: [global@cn.gree.com](mailto:global@cn.gree.com)

**For product improvement, specifications and appearance in this manual are subject to change without prior notice.**